



DOMINO/DEVICE+ CATALOG

OneLab 1.20

Waters™

The pace of innovation in current day biological research demands the highest levels of reproducibility and traceability.

Waters Automation has developed an intelligent cloud-based software environment called **OneLab** within which experiments can be intuitively designed, repeatably executed, and tracked through a rapidly evolving ecosystem of connected devices, Dominos and accessories.

With the constant addition of new capabilities, accessories and consumables in OneLab, this regularly updated catalog provides a complete list of all of the consumables that have been made compatible with our Dominos and Devices.



Dominos are machine-readable consumable holders that create the interface between a variety of different consumable types and the Andrew+ pipetting robot to enable seamless automation of many different laboratory workflows.

Equipped with QR codes housing critical consumable information and ARUCO codes for spatial positioning, Dominos are an indispensable part of any Andrew+ automation configuration.



Device+ units are active devices that elevate both manual and fully automated workflows on the Andrew+ instrument by adding specific functionality while being fully connected to OneLab through WiFi or Ethernet. Just like Dominos, they are equipped with QR codes housing critical consumable information and ARUCO codes for spatial positioning. Use **Device+** units to add the following functionality to your OneLab methods: Shaking, Flow-Through Extractions, Magnetic Bead Separations, Heat-Shaking and Heating/Cooling.

Use the following symbols on each consumable page to identify their compatibility with Waters Connected Pipettes when used with the Andrew+ robot



Compatible



Incompatible



« on-the-fly » :
Only on-the-fly dispensing is possible

1 500

Numeric value :
The minimal volume in μL that the consumable must contain to allow the use of the pipette in OneLab

Any consumable with the Microplate Gripper Compatibility icon can be moved between compatible positions by the Andrew+ robot



Want to buy a Domino, Device+ or Waters Consumable? Use the active links throughout this catalog to go to their page on our e-shop

[SEE THIS DOMINO ON OUR E-SHOP](#)

If you need any assistance:

[Visit our Help Center](#)

[Contact our Sales Specialists](#)

INDEX

DOMINOS

TIP DOMINOS

STANDARD DOMINOS

FOR PLATES AND RESERVOIRS

Microplate Domino	10
Deepwell Microplate Domino	11
Storage Plate Domino	80
96-PCR Plate Domino	134
PCR Cartridge Domino	170
PCR Cartridge Domino	184
Wes and Jess Plate Domino	186
Non-ANSI Plate Domino	188
Landing pad microplate domino	190
100-well HoneyComb Plate Domino	192
Metallic OEM Plate Domino	194
Tilted Microplate Domino	196
Long Edge Tilt Deepwell Domino	206
8-Channel Pipette Reservoir Domino	209

FOR TUBES AND VIALS

24-Well Photoredox Block Domino	211
0.5-0.6mL Microtube Domino	212
Microtube Domino	214
5mL Microtube Domino	219
5mL Round Bottom Tube Domino	237
5mL Cryotube Domino	243
Labeled Test Tube Domino	249
Conical Bottom Tube Domino	251
2mL Cryogenic Storage Vial Domino	256
13mL Tube Domino	258
14mL Round Bottom Test Tube Domino	260
15mL Conical Centrifuge Tube Domino	264
20mL C15 B Glass Vial Domino	267
FLAVER 30mL Glass Vial Domino	274
FLAVER 60mL Glass Vial Domino	276
50mL Conical Centrifuge Tube Domino	279
50mL PrepTube Domino	281
4mL Autosampler Vial Domino	291
SCIEX Universal Vial Domino	293
SCIEX 6X6 TRAY DOMINO	298
5mL Serum Vial Domino	300
8mL Sample Vial Domino	302
10mL Serum Vial Domino	304
20mL Serum Vial Domino	308
20mL Reaction Vial Domino	310
22mL Glass Vial Domino	312
29mL Glass Culture Tube Domino	317
Ø9mm Glass Vial Domino	320
Ø12mm Vial Domino	322
Ø12.5mm Tube and Vial Domino	325
Ø13mm Tube Domino	329
Ø16mm Vial Domino	332
16x90mm Glass Tube Domino	336
Ø16mm 30x Tube Domino	338
Ø19mm Vial Domino	345
Ø21mm Vial Domino	350
Ø23mm Headspace Vial Domino	353
Ø27mm Vial Domino	355
Ø28mm Test Tube Domino	357
Tilted Vial Domino	359

4

5

9

FOR BOTTLES

Ø46mm Bottle Domino	363
Ø51mm Bottle Domino	364
Ø55mm 10x Bottle Domino	366
Nalgene™ 15mL Bottle Domino	368
Nalgene™ 60mL Bottle Domino	370
100mL Bottle Magnetic Stirrer Domino	373
Nalgene™ 125mL Bottle Domino	375
125mL Storage Bottle Domino	377
125mL Square Bottle Domino	379
Nalgene™ 175mL Bottle Domino	381
250mL DURAN bottle Domino	383
500mL Round Bottle Domino	385
Conical Bottom 500mL Tube Domino	388
	391

FOR OTHER CONSUMABLE TYPES

Square Cuvette Domino	393
NucleoBond Xtra Midi Column Domino	394
	399

COOLED DOMINOS

401

FOR PLATES AND RESERVOIRS

96-PCR Plate Cooled Domino	402
384-PCR Plate Cooled Domino	403
8-Channel Reservoir Cooled Domino	406
	409

FOR TUBES AND VIALS

0.5mL Microtube Cooled Domino	411
1.5mL Microtube Cooled Domino	412
2mL Microtube Cooled Domino	414
15mL Tube Cooled Domino	418
50mL Tube Cooled Domino	420
	422

RACK DOMINOS

427

Collection Labware Rack Domino	429
Racked Tubes Domino	447
0.2mL MICROTUBE RACK DOMINO BUNDLE	452
1.2mL Microtube Rack Domino	454
BRAND® 1.2mL Microtube Rack Domino	456
2mL Cryotube Rack Domino	458
2mL HPLC Vial Rack Domino	461
Vials w/ 24x Rack Domino	461
Culture Tube w/ 48x Rack Domino	481
15mL Tube in 15x Rack Domino	484
60x 15mL Centrifuge Tube Rack Domino	486
50mL Tube in 55x Rack Domino	488
250mL Bottle in 18x Rack Domino	492
	494

DEVICE+

496

Microplate Shaker+	497
Tube Shaker+ w/ 12x75mm Tube Adaptor	537
Tube Shaker+ w/ 16x90mm Tube Adaptor	539
Tube Shaker+ w/ 5mL Tube Adaptor	543
Tube Shaker+ With Tilted Vial Adaptor	545
Tube Shaker+ w/40mL Tube Adaptor	547
Microplate Peltier+	549
96-PCR Peltier+	556
96-PCR Magnet+	567
Deepwell Magnet+	571
50mL Tube Magnet+	571
Heater-Shaker+	583
Extraction+	588
	618



DOMINOS



TIP DOMINOS

Ordering product number
186009612
OneLab reference: [218.1101]

TIP INSERTION SYSTEM DOMINO



The Tip Insertion System Domino is a versatile system capable of holding a removable rack of 96x Sartorius OptiFit tips for volumes ranging from 0.2µL-1200µL in both filtered and non-filtered formats. Its force-dispensing design enables even tip insertion across all channels of 8-channel pipettes. All OptiFit tip trays are color-coded for easy matching with a corresponding, color-coded Waters Connected Pipette.

[SEE THIS DOMINO
ON OUR E-SHOP](#)



Manufacturer:
Sartorius

Part number:
Variable

1-channel pipettes

●	●	●	●	●	●
10µL	120µL	300µL	1000µL	5mL	10mL
✓	✓	✓	✓	✗	✗

8-channel pipettes

●	●	●	●
10µL	120µL	300µL	1200µL
✓	✓	✓	✓

IMPORTANT

Sartorius Optifit Tips are supplied in the following packaging types:

- Purity certified single tray racks
- Purity certified refill packs
- Refill towers
- FlexiBulk® boxes

5mL and 10mL Tips are NOT supported on the Tip Insertion System Domino



Ordering product number

186009599

OneLab reference: [218.1252]

5ML TIP RACK HOLDER DOMINO



The 5mL Tip Rack Holder Domino is designed to hold rack inserts of 50x non-filtered and filtered Sartorius OptiFit 5mL tips.

[SEE THIS DOMINO
ON OUR E-SHOP](#)



Manufacturer:
Sartorius

Part number:
Variable

1-channel pipettes

●	●	●	●	●	●
10 μ L	120 μ L	300 μ L	1000 μ L	5mL	10mL
✗	✗	✗	✗	✓	✗

8-channel pipettes

●	●	●	●
10 μ L	120 μ L	300 μ L	1200 μ L
✗	✗	✗	✗

IMPORTANT

Placing 5mL OptiFit tips on the 5mL Tip Rack Holder Domino requires the green, 50x rack insert sold only with Item No. 780304 from Sartorius (5mL OptiFit Racked Pipette Tips).

Ordering product number

186010098

OneLab reference: [218.1202]

10ML TIP RACK HOLDER DOMINO



The 10mL Tip Rack Holder Domino is designed to hold rack inserts of 35x non-filtered Sartorius OptiFit 10mL tips.

[SEE THIS DOMINO
ON OUR E-SHOP](#)



Manufacturer:
Sartorius

Part number:
Variable

1-channel pipettes

●	●	●	●	●	●
10μL	120μL	300μL	1000μL	5mL	10mL
✗	✗	✗	✗	✗	✓

8-channel pipettes

●	●	●	●
10μL	120μL	300μL	1200μL
✗	✗	✗	✗

IMPORTANT

Placing 10mL OptiFit tips on the 10mL Tip Rack Holder Domino requires the red, 35x rack insert **sold only with Item No. LH-780314 from Sartorius (10mL OptiFit Racked Pipette Tips).**

STANDARD DOMINOS

**FOR PLATES
AND RESERVOIRS**

Ordering product number

186009600

OneLab reference: [218.2002]

MICROPLATE DOMINO



The Microplate Domino is designed to hold a growing array of various skirted microplates.

[SEE THIS DOMINO
ON OUR E-SHOP](#)

96-well micro photoredox block assembly



Manufacturer:
Analytical Sales
& Services, Inc.

Part number:
10421-CASE

1-channel pipettes					
10 μ L	120 μ L	300 μ L	1000 μ L	5mL	10mL
✓	20	80	100	🧪	🧪

8-channel pipettes			
10 μ L	120 μ L	300 μ L	1200 μ L
✓	20	80	90



MICROPLATE DOMINO
PN: 186009600

ACC, Pyroclear[®] Pyroplate[®] 96-well microplate

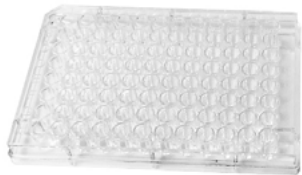

Manufacturer:
Associates of Cape
Cod, Inc.

Part number:
CA961-50



1-channel pipettes					
10 μ L	120 μ L	300 μ L	1000 μ L	5mL	10mL
✓	✓	✓	✓	⚠	⚠

8-channel pipettes			
10 μ L	120 μ L	300 μ L	1200 μ L
✓	✓	✓	✓



MICROPLATE DOMINO
PN: 186009600

ArcticWhite, 7 mL 12-column low-profile reservoir



Manufacturer:
ArcticWhite LLC

Part number:
AWLS-S30028

1-channel pipettes					
10 μ L	120 μ L	300 μ L	1000 μ L	5mL	10mL
✓	✓	✓	✓	✓	✓

8-channel pipettes			
10 μ L	120 μ L	300 μ L	1200 μ L
✓	✓	✓	✓



MICROPLATE DOMINO
PN: 186009600

Armadillo 384-well PCR plate, red



Manufacturer:
Thermo Scientific

Part number:
AB3384R

1-channel pipettes					
10 μ L	120 μ L	300 μ L	1000 μ L	5mL	10mL
✓	✓	✓	✓	⚠	⚠

8-channel pipettes			
10 μ L	120 μ L	300 μ L	1200 μ L
✓	✓	✓	10



MICROPLATE DOMINO
PN: 186009600

Axygen® 500 µL 96-round deep well V-bottom plate



Manufacturer:
Corning Inc.

Part number:
P-96-450V-C-S

1-channel pipettes					
10µL	120µL	300µL	1000µL	5mL	10mL
✓	✓	✓	✓	✗	✗

8-channel pipettes			
10µL	120µL	300µL	1200µL
✓	✓	✓	✓



MICROPLATE DOMINO
PN: 186009600

CELLSTAR® 6-well cell culture plate



Manufacturer:
Greiner Bio-One

Part number:
657160

1-channel pipettes					
10µL	120µL	300µL	1000µL	5mL	10mL
✓	✓	✓	✓	✓	✓

8-channel pipettes			
10µL	120µL	300µL	1200µL
✓	✓	✓	✓



MICROPLATE DOMINO
PN: 186009600

CELLSTAR® 24-well cell culture plate

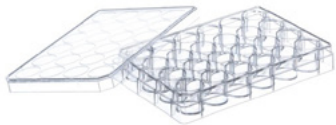

Manufacturer:
Greiner Bio-One

Part number:
662160

1-channel pipettes					
10µL	120µL	300µL	1000µL	5mL	10mL
✓	✓	✓	✓	✓	✓

8-channel pipettes			
10µL	120µL	300µL	1200µL
✗	✗	✗	✗



MICROPLATE DOMINO
PN: 186009600

CELLSTAR® 96-well clear F-bottom cell culture microplate



Manufacturer:
Greiner Bio-One

Part number:
655180



1-channel pipettes

10µL	120µL	300µL	1000µL	5mL	10mL
✓	✓	✓	✓	⚠	⚠

8-channel pipettes

10µL	120µL	300µL	1200µL
✓	✓	✓	✓



MICROPLATE DOMINO
PN: 186009600

Clear C-Shaped Immuno Nonsterile 96-Well Plates



Manufacturer:
Thermo Scientific

Part number:
446612

1-channel pipettes					
10 μ L	120 μ L	300 μ L	1000 μ L	5mL	10mL
✓	✓	✓	✓	⚠	⚠

8-channel pipettes			
10 μ L	120 μ L	300 μ L	1200 μ L
✓	✓	✓	✓



MICROPLATE DOMINO
PN: 186009600

Clear Flat-Bottom Immuno Nonsterile 96-well plate



Manufacturer:
Thermo Scientific

Part number:
439454

1-channel pipettes					
10 μ L	120 μ L	300 μ L	1000 μ L	5mL	10mL
✓	✓	✓	✓	⚠	⚠

8-channel pipettes			
10 μ L	120 μ L	300 μ L	1200 μ L
✓	✓	✓	✓



MICROPLATE DOMINO
PN: 186009600

Clear Flat-Bottom Immuno Nonsterile 96-well plate 2HB



Manufacturer:
Thermo Scientific

Part number:
3455

1-channel pipettes					
10 μ L	120 μ L	300 μ L	1000 μ L	5mL	10mL
✓	✓	✓	✓	⚠	⚠

8-channel pipettes			
10 μ L	120 μ L	300 μ L	1200 μ L
✓	✓	✓	✓



MICROPLATE DOMINO
PN: 186009600

Clickbio, VBLOK 200 mL V-bottom reservoir

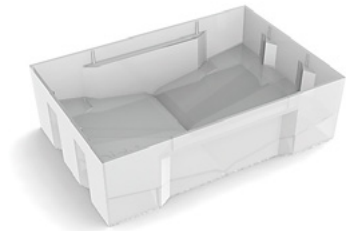

Manufacturer:
ClickBio

Part number:
CBVBLOK200-1

1-channel pipettes

10 μ L	120 μ L	300 μ L	1000 μ L	5mL	10mL
✓	✓	✓	✓	✓	✓

8-channel pipettes

10 μ L	120 μ L	300 μ L	1200 μ L
✓	✓	✓	✓



MICROPLATE DOMINO
PN: 186009600

Corning® 96-well Flat Bottom Polystyrene NBS Microplate



Manufacturer:
Corning Inc.

Part number:
3651

1-channel pipettes					
10µL	120µL	300µL	1000µL	5mL	10mL
✓	✓	✓	✓	⚠	⚠

8-channel pipettes			
10µL	120µL	300µL	1200µL
✓	✓	✓	✓



MICROPLATE DOMINO
PN: 186009600

Corning® 96-Well TC-Treated Microplate



Manufacturer:
Corning Inc.

Part number:
3585

1-channel pipettes					
10µL	120µL	300µL	1000µL	5mL	10mL
✓	✓	✓	✓	⚠	⚠

8-channel pipettes			
10µL	120µL	300µL	1200µL
✓	✓	✓	✓



MICROPLATE DOMINO
PN: 186009600

Corning® 96-well U-bottom TC-treated microplate



Manufacturer:
Corning Inc.

Part number:
3799

1-channel pipettes					
10 μ L	120 μ L	300 μ L	1000 μ L	5mL	10mL
✓	✓	✓	✓	✓	✓

8-channel pipettes			
10 μ L	120 μ L	300 μ L	1200 μ L
✓	✓	✓	✓



MICROPLATE DOMINO
PN: 186009600

Corning® 384-Well Clear Round Bottom Microplate

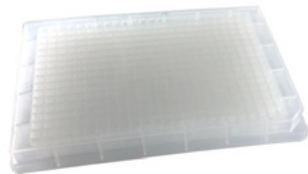

Manufacturer:
Corning Inc.

Part number:
3656



1-channel pipettes					
10µL	120µL	300µL	1000µL	5mL	10mL
✓	✓	✓	✓	⚠	⚠

8-channel pipettes			
10µL	120µL	300µL	1200µL
✓	✓	✓	✓



MICROPLATE DOMINO
PN: 186009600

Corning® CellBIND® 360 µL 96-well clear bottom black microplate



Manufacturer:

Corning Inc.

Part number:

3340

1-channel pipettes

10µL	120µL	300µL	1000µL	5mL	10mL
✓	✓	✓	✓	⚠	⚠

8-channel pipettes

10µL	120µL	300µL	1200µL
✓	✓	✓	✓



MICROPLATE DOMINO
PN: 186009600

Corning® CellBIND® 360 µL 96-well clear bottom black microplate



Manufacturer:
Corning Inc.

Part number:
3340

1-channel pipettes					
10µL	120µL	300µL	1000µL	5mL	10mL
✓	✓	✓	✓	⚠	⚠

8-channel pipettes			
10µL	120µL	300µL	1200µL
✓	✓	✓	✓



MICROPLATE DOMINO
PN: 186009600

Corning® low-volume 384-well clear F-bottom black microplate

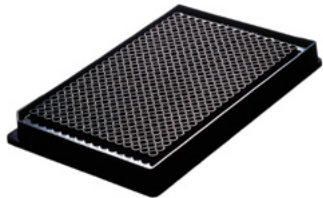

Manufacturer:
Corning Inc.

Part number:
3542

1-channel pipettes					
10 μ L	120 μ L	300 μ L	1000 μ L	5mL	10mL
✓	✓	✓	🚫	🚫	🚫

8-channel pipettes			
10 μ L	120 μ L	300 μ L	1200 μ L
✓	✓	✓	✓



MICROPLATE DOMINO
PN: 186009600

Corning® low-volume 384-well white F-bottom microplate

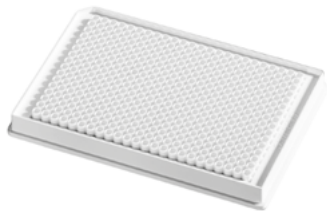

Manufacturer:
Corning Inc.

Part number:
3826

1-channel pipettes					
10µL	120µL	300µL	1000µL	5mL	10mL
✓	✓	✓	✓	⚠	⚠

8-channel pipettes			
10µL	120µL	300µL	1200µL
✓	✓	✓	✓



MICROPLATE DOMINO
PN: 186009600

Costar® 48-well cell culture plate



Manufacturer:
Corning Inc.

Part number:
3548

1-channel pipettes					
10 μ L	120 μ L	300 μ L	1000 μ L	5mL	10mL
✓	✓	✓	✓	✓	✓

8-channel pipettes			
10 μ L	120 μ L	300 μ L	1200 μ L
✗	✗	✗	✗



MICROPLATE DOMINO
PN: 186009600

DURAN® 10 mL clear glass laboratory bottle in 2x3 position holder



Manufacturer:
DWK Life Sciences

Part number:
218010851

1-channel pipettes					
10µL	120µL	300µL	1000µL	5mL	10mL
✓	✓	✓	✓	✓	✓

8-channel pipettes			
10µL	120µL	300µL	1200µL
✗	✗	✗	✗



MICROPLATE DOMINO
PN: 186009600

DURAN® 25 mL clear glass laboratory bottle in 2x3 position holder



Manufacturer:
DWK Life Sciences

Part number:
218011404

1-channel pipettes					
10µL	120µL	300µL	1000µL	5mL	10mL
✓	✓	✓	✓	✓	✓

8-channel pipettes			
10µL	120µL	300µL	1200µL
✗	✗	✗	✗



MICROPLATE DOMINO
PN: 186009600

Eppendorf twin.tec[®] 96-well skirted LoBind[®] PCR plate



Manufacturer:
Eppendorf

Part number:
0030129555



1-channel pipettes					
10µL	120µL	300µL	1000µL	5mL	10mL
✓	✓	✓	✓	⚠	⚠

8-channel pipettes			
10µL	120µL	300µL	1200µL
✓	✓	✓	✓



MICROPLATE DOMINO
PN: 186009600

FrameStar® 0.1 mL 96-well skirted low profile PCR plate, clear wells

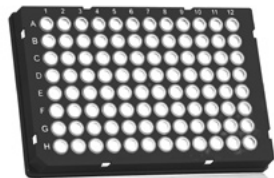

Manufacturer:
Azenta Life Sciences

Part number:
4ti-0960/RIG



1-channel pipettes

10µL	120µL	300µL	1000µL	5mL	10mL
✓	✓	✓	✓	⚠	⚠

8-channel pipettes

10µL	120µL	300µL	1200µL
✓	✓	✓	✓



MICROPLATE DOMINO
PN: 186009600

FrameStar® break-a-way PCR plate in 96x FrameStrip® adapter

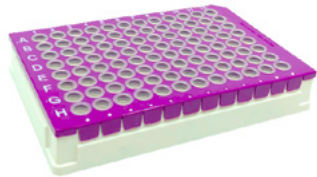

Manufacturer:
Azenta Life Sciences

Part number:
4ti-1000/P

1-channel pipettes					
10µL	120µL	300µL	1000µL	5mL	10mL
✓	✓	✓	✓	✗	✗

8-channel pipettes			
10µL	120µL	300µL	1200µL
✓	✓	✓	✓



MICROPLATE DOMINO
PN: 186009600

FrameStrip® 8-well PCR tube strip in 96x FrameStrip® adapter

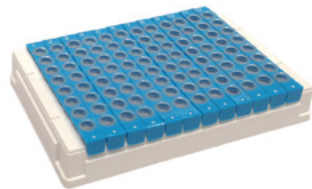

Manufacturer:
Azenta Life Sciences

Part number:
4ti-0786/B

1-channel pipettes					
10µL	120µL	300µL	1000µL	5mL	10mL
✓	✓	✓	✓	⚠	⚠

8-channel pipettes			
10µL	120µL	300µL	1200µL
✓	✓	✓	✓



MICROPLATE DOMINO
PN: 186009600

Greiner, 96-well PP U-bottom clear microplate



Manufacturer:
Greiner Bio-One

Part number:
650261

1-channel pipettes					
10 μ L	120 μ L	300 μ L	1000 μ L	5mL	10mL
✓	✓	✓	✓	✓	✓

8-channel pipettes			
10 μ L	120 μ L	300 μ L	1200 μ L
✓	✓	✓	✓



MICROPLATE DOMINO
PN: 186009600

Greiner, 96-well PP V-bottom clear microplate

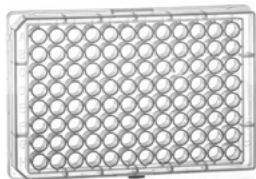

Manufacturer:
Greiner Bio-One

Part number:
651201

1-channel pipettes					
10 μ L	120 μ L	300 μ L	1000 μ L	5mL	10mL
✓	✓	✓	✓	⚠	⚠

8-channel pipettes			
10 μ L	120 μ L	300 μ L	1200 μ L
✓	✓	✓	✓



MICROPLATE DOMINO
PN: 186009600

Greiner, 96-well PS F-bottom clear microplate



Manufacturer:
Greiner Bio-One

Part number:
655101



1-channel pipettes

10 μ L	120 μ L	300 μ L	1000 μ L	5mL	10mL
✓	✓	✓	✓	✗	✗

8-channel pipettes

10 μ L	120 μ L	300 μ L	1200 μ L
✓	✓	✓	✓



MICROPLATE DOMINO
PN: 186009600

Greiner, 384-well PP F-bottom black microplate

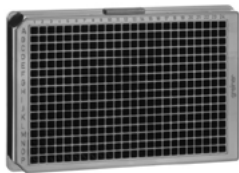

Manufacturer:
Greiner Bio-One

Part number:
781209

1-channel pipettes					
10 μ L	120 μ L	300 μ L	1000 μ L	5mL	10mL
✓	✓	✓	✓	⚠	⚠

8-channel pipettes			
10 μ L	120 μ L	300 μ L	1200 μ L
✓	✓	✓	✓



MICROPLATE DOMINO
PN: 186009600

Greiner, 384-well PS F-bottom clear microplate

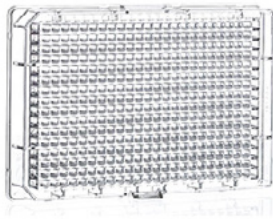

Manufacturer:
Greiner Bio-One

Part number:
781101

1-channel pipettes					
10 μ L	120 μ L	300 μ L	1000 μ L	5mL	10mL
✓	✓	✓	⚠	✗	✗

8-channel pipettes			
10 μ L	120 μ L	300 μ L	1200 μ L
✓	✓	✓	⚠



MICROPLATE DOMINO
PN: 186009600

Greiner, 384-well white Small Volume™ HiBase microplate

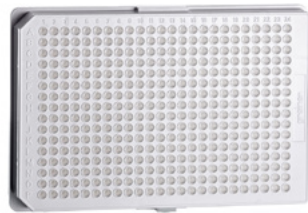

Manufacturer:
Greiner Bio-One

Part number:
784075

1-channel pipettes					
10µL	120µL	300µL	1000µL	5mL	10mL
✓	✓	✓	⚠	✗	✗

8-channel pipettes			
10µL	120µL	300µL	1200µL
✓	✓	✓	⚠



MICROPLATE DOMINO
PN: 186009600

Hard-Shell® 96-well low-profile skirted PCR plate, white/clear



Manufacturer:
Bio-Rad Laboratories

Part number:
HSP9601



1-channel pipettes					
10µL	120µL	300µL	1000µL	5mL	10mL
✓	✓	✓	✓	⚠	⚠

8-channel pipettes			
10µL	120µL	300µL	1200µL
✓	✓	✓	✓



MICROPLATE DOMINO
PN: 186009600

Hard-Shell® 384-well skirted PCR plate, black/white



Manufacturer:
Bio-Rad Laboratories

Part number:
HSP3865

1-channel pipettes					
10µL	120µL	300µL	1000µL	5mL	10mL
✓	✓	✓	⚠	✗	✗

8-channel pipettes			
10µL	120µL	300µL	1200µL
✓	✓	✓	⚠



MICROPLATE DOMINO
PN: 186009600

Hard-Shell® 384-well skirted PCR plate, clear/white



Manufacturer:
Greiner Bio-One

Part number:
HSP3805

1-channel pipettes					
10µL	120µL	300µL	1000µL	5mL	10mL
✓	✓	✓	⚠	✗	✗

8-channel pipettes			
10µL	120µL	300µL	1200µL
✓	✓	✓	⚠



MICROPLATE DOMINO
PN: 186009600

HardShell 96-well low-profile skirted PCR plate, blue/clear



Manufacturer:
PerkinElmer, Inc.

Part number:
6008870



1-channel pipettes

10 μ L	120 μ L	300 μ L	1000 μ L	5mL	10mL
✓	✓	✓	✓	⚠	⚠

8-channel pipettes

10 μ L	120 μ L	300 μ L	1200 μ L
✓	✓	✓	✓



MICROPLATE DOMINO
PN: 186009600

Headspace 10mL Screw-Thread Vials, in 15 positions rack



Manufacturer:
Restek

Part number:
23084

1-channel pipettes					
10 μ L	120 μ L	300 μ L	1000 μ L	5mL	10mL
✓	✓	✓	✓	✓	✓

8-channel pipettes			
10 μ L	120 μ L	300 μ L	1200 μ L
✗	✗	✗	✗



MICROPLATE DOMINO
PN: 186009600

Headspace 20mL Screw-Thread Vials, in 15 positions rack



Manufacturer:

Restek

Part number:

23082

1-channel pipettes					
10 μ L	120 μ L	300 μ L	1000 μ L	5mL	10mL
✓	✓	✓	✓	✓	1 000

8-channel pipettes			
10 μ L	120 μ L	300 μ L	1200 μ L
✗	✗	✗	✗



MICROPLATE DOMINO
PN: 186009600

High Binding 96-Stripwell™ Flat Bottom Microplate

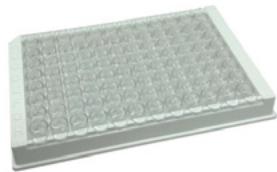

Manufacturer:
Corning Inc.

Part number:
7642

1-channel pipettes					
10µL	120µL	300µL	1000µL	5mL	10mL
✓	✓	✓	✓	✓	⚠

8-channel pipettes			
10µL	120µL	300µL	1200µL
✓	✓	✓	✓



MICROPLATE DOMINO
PN: 186009600

ibidi, 24-well ibiTreat black μ -Plate w/ polymer coverslip bottom



Manufacturer:
ibidi

Part number:
82426

1-channel pipettes					
10 μ L	120 μ L	300 μ L	1000 μ L	5mL	10mL
✓	✓	✓	✓	✓	✓

8-channel pipettes			
10 μ L	120 μ L	300 μ L	1200 μ L
✗	✗	✗	✗



MICROPLATE DOMINO
PN: 186009600

ibidi, 96-well ibiTreat black μ -Plate w/ polymer coverslip bottom



Manufacturer:
ibidi

Part number:
89626

1-channel pipettes

10 μ L	120 μ L	300 μ L	1000 μ L	5mL	10mL
✓	✓	✓	✓	✓	✓

8-channel pipettes

10 μ L	120 μ L	300 μ L	1200 μ L
✓	✓	✓	✓



MICROPLATE DOMINO
PN: 186009600

KingFisher™ 200uL Systems Consumable



Manufacturer:
Thermo Scientific

Part number:
97002084

1-channel pipettes					
10µL	120µL	300µL	1000µL	5mL	10mL
✓	✓	✓	✓	⚠	⚠

8-channel pipettes			
10µL	120µL	300µL	1200µL
✓	✓	✓	✓



MICROPLATE DOMINO
PN: 186009600

MicroAmp™ 40 µL optical 384-well skirted reaction plate w/ barcode



Manufacturer:
Applied Biosystems

Part number:
4309849

1-channel pipettes					
10µL	120µL	300µL	1000µL	5mL	10mL
✓	✓	✓	⚠	⚠	✗

8-channel pipettes			
10µL	120µL	300µL	1200µL
✓	✓	✓	⚠



MICROPLATE DOMINO
PN: 186009600

MICROLON® 200 96-well U-bottom microplate

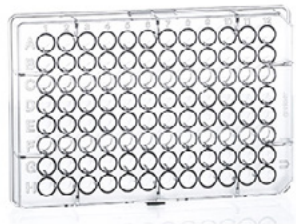

Manufacturer:
Greiner Bio-One

Part number:
650001

1-channel pipettes					
10µL	120µL	300µL	1000µL	5mL	10mL
✓	✓	✓	✓	⚠	⚠

8-channel pipettes			
10µL	120µL	300µL	1200µL
✓	✓	✓	✓



MICROPLATE DOMINO
PN: 186009600

MultiScreen® Solvinert™ 96-well filter plate, 0.45 µm pore size



Manufacturer:
Merck

Part number:
MSRLN0450

1-channel pipettes					
10µL	120µL	300µL	1000µL	5mL	10mL
✓	✓	✓	✓	⚠	⚠

8-channel pipettes			
10µL	120µL	300µL	1200µL
✓	✓	✓	✓



MICROPLATE DOMINO
PN: 186009600

Nunc™ 6-well cell culture-treated plate



Manufacturer:
Thermo Scientific

Part number:
140675

1-channel pipettes					
10 μ L	120 μ L	300 μ L	1000 μ L	5mL	10mL
✓	✓	✓	✓	✓	✓

8-channel pipettes			
10 μ L	120 μ L	300 μ L	1200 μ L
✗	✗	✗	✗



MICROPLATE DOMINO
PN: 186009600

Nunc™ 96-well Polypropylene Sample Plate



Manufacturer:
Thermo Scientific

Part number:
249944

1-channel pipettes

10 μ L	120 μ L	300 μ L	1000 μ L	5mL	10mL
✓	✓	✓	✓	⚠	⚠

8-channel pipettes

10 μ L	120 μ L	300 μ L	1200 μ L
✓	✓	✓	✓



MICROPLATE DOMINO
PN: 186009600

Nunc™ 96-Well Polypropylene Sample Plates



Manufacturer:
Thermo Scientific

Part number:
267334

1-channel pipettes					
10µL	120µL	300µL	1000µL	5mL	10mL
✓	✓	✓	✓	✓	✓

8-channel pipettes			
10µL	120µL	300µL	1200µL
✓	✓	✓	✓



MICROPLATE DOMINO
PN: 186009600

Nunc™ Edge™ 96-well cell culture-treated microplate



Manufacturer:
Thermo Scientific

Part number:
167425

1-channel pipettes					
10µL	120µL	300µL	1000µL	5mL	10mL
✓	✓	✓	✓	⚠	⚠

8-channel pipettes			
10µL	120µL	300µL	1200µL
✓	✓	✓	✓



MICROPLATE DOMINO
PN: 186009600

PerkinElmer, AlphaPlate-384 light gray microplate, untreated



Manufacturer:
PerkinElmer, Inc.

Part number:
6005350

1-channel pipettes					
10 μ L	120 μ L	300 μ L	1000 μ L	5mL	10mL
✓	✓	✓	✓	⚠	⚠

8-channel pipettes			
10 μ L	120 μ L	300 μ L	1200 μ L
✓	✓	✓	✓



MICROPLATE DOMINO
PN: 186009600

PerkinElmer, DBS microplate



Manufacturer:
PerkinElmer, Inc.

Part number:
3033-0010

1-channel pipettes					
10 μ L	120 μ L	300 μ L	1000 μ L	5mL	10mL
✓	✓	✓	✓	⚠	⚠

8-channel pipettes			
10 μ L	120 μ L	300 μ L	1200 μ L
✓	✓	✓	✓



MICROPLATE DOMINO
PN: 186009600

Pierce™ 96-Well Polystyrene Plates with Corner Notch



Manufacturer:
Thermo Scientific

Part number:
15041

1-channel pipettes					
10µL	120µL	300µL	1000µL	5mL	10mL
✓	✓	✓	✓	✓	⚠

8-channel pipettes			
10µL	120µL	300µL	1200µL
✓	✓	✓	✓



MICROPLATE DOMINO
PN: 186009600

ProxiPlate™-384 Plus white shallow-well microplate



Manufacturer:
PerkinElmer, Inc.

Part number:
6008280

1-channel pipettes					
10µL	120µL	300µL	1000µL	5mL	10mL
✓	✓	🧪	🧪	🧪	🧪

8-channel pipettes			
10µL	120µL	300µL	1200µL
✓	✓	🧪	🧪



MICROPLATE DOMINO
PN: 186009600

SAFE® 2D MX 500 external thread tube in 96x rack

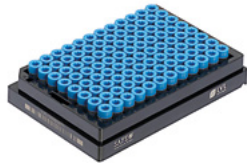

Manufacturer:
LVL technologies

Part number:
2DNC-X05-BL-NS-
SLP-L

1-channel pipettes					
10µL	120µL	300µL	1000µL	5mL	10mL
✓	✓	✓	150	🚫	✗

8-channel pipettes			
10µL	120µL	300µL	1200µL
✓	✓	✓	✓



MICROPLATE DOMINO
PN: 186009600

Thermo Scientific™ 0.3 mL 96-well U-bottom MaxiSorp Immuno plate



Manufacturer:
Thermo Scientific

Part number:
449824

1-channel pipettes					
10 μ L	120 μ L	300 μ L	1000 μ L	5mL	10mL
✓	✓	✓	✓	✓	✓

8-channel pipettes			
10 μ L	120 μ L	300 μ L	1200 μ L
✓	✓	✓	✓



MICROPLATE DOMINO
PN: 186009600

Thermo Scientific™ 400 µL Immuno Standard black 16-well strips in 96x plate



Manufacturer:
Thermo Scientific

Part number:
475515

1-channel pipettes					
10µL	120µL	300µL	1000µL	5mL	10mL
✓	✓	✓	✓	⚠	⚠

8-channel pipettes			
10µL	120µL	300µL	1200µL
✓	✓	✓	✓



MICROPLATE DOMINO
PN: 186009600

Thermo Scientific™ KingFisher™ 96-well microplate



Manufacturer:
Thermo Scientific

Part number:
97002540

1-channel pipettes					
10 μ L	120 μ L	300 μ L	1000 μ L	5mL	10mL
✓	✓	✓	✓	✓	⚠

8-channel pipettes			
10 μ L	120 μ L	300 μ L	1200 μ L
✓	✓	✓	✓



MICROPLATE DOMINO
PN: 186009600

Thermo Scientific™ Nunc MicroWell 96-well plate



Manufacturer:
Thermo Scientific

Part number:
269620

1-channel pipettes					
10 μ L	120 μ L	300 μ L	1000 μ L	5mL	10mL
✓	✓	✓	✓	⚠	⚠

8-channel pipettes			
10 μ L	120 μ L	300 μ L	1200 μ L
✓	✓	✓	✓



MICROPLATE DOMINO
PN: 186009600

TPP 12-well tissue culture test plate



Manufacturer:
TPP AG

Part number:
92412



1-channel pipettes					
10 μ L	120 μ L	300 μ L	1000 μ L	5mL	10mL
✓	✓	✓	✓	✓	✓

8-channel pipettes			
10 μ L	120 μ L	300 μ L	1200 μ L
✗	✗	✗	✗



MICROPLATE DOMINO
PN: 186009600

Unchained Labs, Big Lunatic plate



Manufacturer:
Unchained Labs

Part number:
N/A

1-channel pipettes					
10 μ L	120 μ L	300 μ L	1000 μ L	5mL	10mL
✓	✗	✗	✗	✗	✗

8-channel pipettes			
10 μ L	120 μ L	300 μ L	1200 μ L
✓	✗	✗	✗



MICROPLATE DOMINO
PN: 186009600

UV-Star® μ Clear® 96-well F-bottom half-area microplate

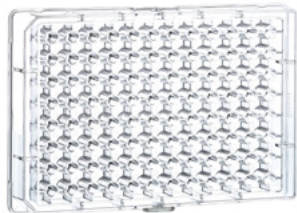

Manufacturer:
Greiner Bio-One

Part number:
675801

1-channel pipettes					
10 μ L	120 μ L	300 μ L	1000 μ L	5mL	10mL
✓	✓	✓	✓	⚠	⚠

8-channel pipettes			
10 μ L	120 μ L	300 μ L	1200 μ L
✓	✓	✓	✓



MICROPLATE DOMINO
PN: 186009600

UV-Star® μ Clear® 96-well F-bottom microplate



Manufacturer:
Greiner Bio-One

Part number:
655801

1-channel pipettes					
10 μ L	120 μ L	300 μ L	1000 μ L	5mL	10mL
✓	✓	✓	✓	✗	✗

8-channel pipettes			
10 μ L	120 μ L	300 μ L	1200 μ L
✓	✓	✓	✓



MICROPLATE DOMINO
PN: 186009600

Valita® Titer assay plate



Manufacturer:
ValitaCell

Part number:
VAL003

1-channel pipettes

10µL	120µL	300µL	1000µL	5mL	10mL
✓	✓	✓	✓	✓	✓

8-channel pipettes

10µL	120µL	300µL	1200µL
✓	✓	✓	✓



MICROPLATE DOMINO
PN: 186009600

Valita® Titer plate



Manufacturer:
ValitaCell

Part number:
VAL003

1-channel pipettes					
10µL	120µL	300µL	1000µL	5mL	10mL
✓	✓	✓	✓	✓	✓

8-channel pipettes			
10µL	120µL	300µL	1200µL
✓	✓	✓	✓



MICROPLATE DOMINO
PN: 186009600

Waters 250 μ L 384-square well collection plate



SEE THIS CONSUMABLE
ON OUR E-SHOP

Manufacturer:
Waters Corporation

Part number:
186002632

1-channel pipettes					
10 μ L	120 μ L	300 μ L	1000 μ L	5mL	10mL
✓	✓	75	150	🧪	🧪

8-channel pipettes			
10 μ L	120 μ L	300 μ L	1200 μ L
✗	✗	✗	✗



MICROPLATE DOMINO
PN: 186009600

Waters 350 μ L 96-round well collection plate



SEE THIS CONSUMABLE
ON OUR E-SHOP

Manufacturer:
Waters Corporation

Part number:
186002643



1-channel pipettes

10 μ L	120 μ L	300 μ L	1000 μ L	5mL	10mL
✓	✓	✓	✓	✓	✓

8-channel pipettes

10 μ L	120 μ L	300 μ L	1200 μ L
✓	✓	✓	✓



MICROPLATE DOMINO
PN: 186009600

WebSeal 0.5 mL 96-well V-bottom plate



Manufacturer:
Thermo Scientific

Part number:
60180-P100



1-channel pipettes					
10 μ L	120 μ L	300 μ L	1000 μ L	5mL	10mL
✓	✓	✓	✓	⚠	⚠

8-channel pipettes			
10 μ L	120 μ L	300 μ L	1200 μ L
✓	✓	✓	✓



MICROPLATE DOMINO
PN: 186009600

Ordering product number

186009597

OneLab reference: [218.2301]

DEEPWELL MICROPLATE DOMINO



The Deepwell Microplate Domino is designed to hold a growing array of Deepwell plates and reagent reservoirs capable of holding large volumes.

**SEE THIS DOMINO
ON OUR E-SHOP**

2 mL aluminum 48-well reaction block

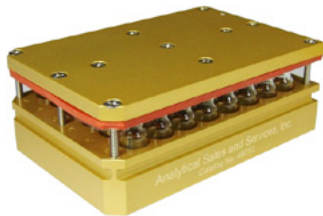

Manufacturer:
Analytical Sales
& Services, Inc.

Part number:
48012

1-channel pipettes					
10 μ L	120 μ L	300 μ L	1000 μ L	5mL	10mL
✓	✓	✓	1 100	1 200	🧪

8-channel pipettes			
10 μ L	120 μ L	300 μ L	1200 μ L
✗	✗	✗	✗



DEEPWELL MICROPLATE
DOMINO
PN: 186009597

4 mL aluminum 24-well reaction block



Manufacturer:
Analytical Sales
& Services, Inc.

Part number:
24015

1-channel pipettes					
10 μ L	120 μ L	300 μ L	1000 μ L	5mL	10mL
✓	✓	✓	✓	2 500	🧪

8-channel pipettes			
10 μ L	120 μ L	300 μ L	1200 μ L
✗	✗	✗	✗



DEEPWELL MICROPLATE
DOMINO
PN: 186009597

8 mL aluminum 24-well reaction block



Manufacturer:
Analytical Sales
& Services, Inc.

Part number:
24017

1-channel pipettes					
10 μ L	120 μ L	300 μ L	1000 μ L	5mL	10mL
✓	✓	✓	✓	3 000	6 000

8-channel pipettes			
10 μ L	120 μ L	300 μ L	1200 μ L
✗	✗	✗	✗



DEEPWELL MICROPLATE
DOMINO
PN: 186009597

96-well photoredox block assembly



Manufacturer:
Analytical Sales
& Services, Inc.

Part number:
96973

1-channel pipettes					
10 μ L	120 μ L	300 μ L	1000 μ L	5mL	10mL
200	✓	✓	400	400	600

8-channel pipettes			
10 μ L	120 μ L	300 μ L	1200 μ L
200	✓	✓	✓



DEEPWELL MICROPLATE
DOMINO
PN: 186009597

Abgene™ 0.8 mL 96-deep well storage plate

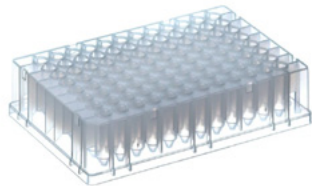

Manufacturer:
Thermo Scientific

Part number:
AB0859



1-channel pipettes					
10µL	120µL	300µL	1000µL	5mL	10mL
✓	✓	✓	50	200	400

8-channel pipettes			
10µL	120µL	300µL	1200µL
200	✓	✓	✓



DEEPPWELL MICROPLATE
DOMINO
PN: 186009597

Abgene™ 2.2mL 96-well Deepwell Sample Plate



Manufacturer:
Thermo Scientific

Part number:
AB-0661

1-channel pipettes					
10µL	120µL	300µL	1000µL	5mL	10mL
✓	✓	✓	✓	✓	✓

8-channel pipettes			
10µL	120µL	300µL	1200µL
600	✓	✓	✓



DEEPWELL MICROPLATE
DOMINO
PN: 186009597

Abgene™ 96 Well 1.2mL Deepwell Plate



Manufacturer:
Thermo Scientific

Part number:
AB1127

1-channel pipettes					
10µL	120µL	300µL	1000µL	5mL	10mL
✓	✓	✓	800	✓	✓

8-channel pipettes			
10µL	120µL	300µL	1200µL
300	✓	✓	200



DEEPWELL MICROPLATE
DOMINO
PN: 186009597

AcroPrep™ 24-well collection plate



Manufacturer:
Pall Corporation

Part number:
NA



1-channel pipettes					
10µL	120µL	300µL	1000µL	5mL	10mL
✓	✓	✓	✓	✓	✓

8-channel pipettes			
10µL	120µL	300µL	1200µL
✗	✗	✗	✗



DEEPWELL MICROPLATE
DOMINO
PN: 186009597

Agilent 6-column reagent reservoir



Manufacturer:
Agilent Technologies

Part number:
201284-100

1-channel pipettes					
10 μ L	120 μ L	300 μ L	1000 μ L	5mL	10mL
✓	✓	✓	✓	✓	✓

8-channel pipettes			
10 μ L	120 μ L	300 μ L	1200 μ L
6 000	✓	✓	✓



DEEPWELL MICROPLATE
DOMINO
PN: 186009597

Agilent 12-column reagent reservoir



Manufacturer:
Agilent Technologies

Part number:
201256-100

1-channel pipettes					
10 μ L	120 μ L	300 μ L	1000 μ L	5mL	10mL
✓	✓	✓	✓	✓	16 000

8-channel pipettes			
10 μ L	120 μ L	300 μ L	1200 μ L
10 000	✓	✓	✓



DEEPWELL MICROPLATE
DOMINO
PN: 186009597

Agilent 96-well plate, 2.2 mL



Manufacturer:
Agilent Technologies

Part number:
5043-9300



1-channel pipettes					
10 μ L	120 μ L	300 μ L	1000 μ L	5mL	10mL
✓	✓	✓	✓	300	750

8-channel pipettes			
10 μ L	120 μ L	300 μ L	1200 μ L
300	✓	✓	✓



DEEPWELL MICROPLATE
DOMINO
PN: 186009597

ArcticWhite, 21 mL 12-column reservoir



Manufacturer:
ArcticWhite LLC

Part number:
AWLS-S30019

1-channel pipettes					
10 μ L	120 μ L	300 μ L	1000 μ L	5mL	10mL
✓	✓	✓	✓	5 000	10 000

8-channel pipettes			
10 μ L	120 μ L	300 μ L	1200 μ L
✓	✓	✓	✓



DEERWELL MICROPLATE
DOMINO
PN: 186009597

ArcticWhite, 73 mL 4-column reservoir



Manufacturer:
ArcticWhite LLC

Part number:
AWLS-S30051

1-channel pipettes

10 μ L	120 μ L	300 μ L	1000 μ L	5mL	10mL
✓	✓	✓	✓	✓	✓

8-channel pipettes

10 μ L	120 μ L	300 μ L	1200 μ L
✓	✓	✓	✓



DEERWELL MICROPLATE
DOMINO
PN: 186009597

Axygen® 1.1 mL 96-round deep well U-bottom plate



Manufacturer:
Corning Inc.

Part number:
P-DW-11-C



1-channel pipettes					
10µL	120µL	300µL	1000µL	5mL	10mL
✓	✓	✓	✓	✓	✓

8-channel pipettes			
10µL	120µL	300µL	1200µL
300	✓	✓	✓



DEEPPWELL MICROPLATE
DOMINO
PN: 186009597

Axygen® 10 mL 24-square deep well V-bottom plate



Manufacturer:
Corning Inc.

Part number:
P-DW-10ML-24-C-S



1-channel pipettes					
10µL	120µL	300µL	1000µL	5mL	10mL
✓	✓	✓	✓	✓	✓

8-channel pipettes			
10µL	120µL	300µL	1200µL
✗	✗	✗	✗



DEEPWELL MICROPLATE
DOMINO
PN: 186009597

Axygen[®] 8-well reservoir, 8-channel trough



Manufacturer:
Corning Inc.

Part number:
RES-MW8-HP

1-channel pipettes					
10 μ L	120 μ L	300 μ L	1000 μ L	5mL	10mL
✓	✓	✓	✓	15 000	15 000

8-channel pipettes			
10 μ L	120 μ L	300 μ L	1200 μ L
15 000	✓	✓	✓



DEERWELL MICROPLATE
DOMINO
PN: 186009597

Axygen® 12-well reservoir, 12-channel trough



Manufacturer:
Corning Inc.

Part number:
RES-MW12-HP

1-channel pipettes					
10µL	120µL	300µL	1000µL	5mL	10mL
✓	✓	✓	✓	7 500	7 500

8-channel pipettes			
10µL	120µL	300µL	1200µL
7 500	✓	✓	✓



DEEPWELL MICROPLATE
DOMINO
PN: 186009597

BRAND® 1.1 mL 96-deep well U-bottom plate



Manufacturer:
BRAND

Part number:
701350

1-channel pipettes					
10µL	120µL	300µL	1000µL	5mL	10mL
✓	✓	✓	700	500	

8-channel pipettes			
10µL	120µL	300µL	1200µL
15 000	✓	✓	✓





DEEPWELL MICROPLATE
DOMINO
PN: 186009597

Corning® 1.2 mL 8 cluster tube-strip in 96x rack



Manufacturer:
Corning Inc.

Part number:
4412

1-channel pipettes					
10µL	120µL	300µL	1000µL	5mL	10mL
400	200	200	700		

8-channel pipettes			
10µL	120µL	300µL	1200µL
400	200	200	300



DEEPWELL MICROPLATE
DOMINO
PN: 186009597

Corning® 2 mL 96-square deep well V-bottom plate



Manufacturer:
Corning Inc.

Part number:
3960



1-channel pipettes

10µL	120µL	300µL	1000µL	5mL	10mL
✓	✓	✓	✓	700	

8-channel pipettes

10µL	120µL	300µL	1200µL
800	✓	✓	✓



DEEPPWELL MICROPLATE
DOMINO
PN: 186009597

Cytiva, UNIPLATE 5 mL 48-well flat bottom plate



Manufacturer:
Cytiva

Part number:
7701-5500

1-channel pipettes					
10 μ L	120 μ L	300 μ L	1000 μ L	5mL	10mL
✓	✓	✓	✓	3 000	3 000

8-channel pipettes			
10 μ L	120 μ L	300 μ L	1200 μ L
2 500	✓	✓	✓



DEERWELL MICROPLATE
DOMINO
PN: 186009597

Cytiva, UNIPLATE 10 mL 24-well U-shaped plate



Manufacturer:
Cytiva

Part number:
7701-5102

1-channel pipettes					
10 μ L	120 μ L	300 μ L	1000 μ L	5mL	10mL
✓	✓	✓	✓	✓	✓

8-channel pipettes			
10 μ L	120 μ L	300 μ L	1200 μ L
✗	✗	✗	✗



DEEPWELL MICROPLATE
DOMINO
PN: 186009597

Eppendorf 0.5 mL 96-deep well protein LoBind® plate, yellow frame



Manufacturer:
Eppendorf

Part number:
0030504119



1-channel pipettes					
10µL	120µL	300µL	1000µL	5mL	10mL
✓	✓	✓	✓	✓	300

8-channel pipettes			
10µL	120µL	300µL	1200µL
300	✓	✓	✓



DEEPWELL MICROPLATE
DOMINO
PN: 186009597

Eppendorf 1 mL 96-deep well protein LoBind® plate, yellow frame



Manufacturer:
Eppendorf

Part number:
0030504216



1-channel pipettes					
10µL	120µL	300µL	1000µL	5mL	10mL
✓	✓	✓	600	650	

8-channel pipettes			
10µL	120µL	300µL	1200µL
500	✓	✓	✓



DEEPWELL MICROPLATE
DOMINO
PN: 186009597

Eppendorf 2 mL 96-deep well protein LoBind® plate, white frame



Manufacturer:
Eppendorf

Part number:
0030504305



1-channel pipettes					
10µL	120µL	300µL	1000µL	5mL	10mL
✓	✓	✓	✓	700	1 300

8-channel pipettes			
10µL	120µL	300µL	1200µL
900	✓	✓	✓



DEEPWELL MICROPLATE
DOMINO
PN: 186009597

Eppendorf 2 mL 96-square deep well plate, yellow frame



Manufacturer:
Eppendorf

Part number:
0030501314



1-channel pipettes					
10 μ L	120 μ L	300 μ L	1000 μ L	5mL	10mL
✓	✓	✓	✓	700	1 300

8-channel pipettes			
10 μ L	120 μ L	300 μ L	1200 μ L
500	✓	✓	✓



DEEPWELL MICROPLATE
DOMINO
PN: 186009597

Eppendorf™ Deepwell™ Plates 96



Manufacturer:
Eppendorf

Part number:
951033308

1-channel pipettes					
10µL	120µL	300µL	1000µL	5mL	10mL
✓	✓	✓	500	500	700

8-channel pipettes			
10µL	120µL	300µL	1200µL
300	✓	✓	✓



DEEPWELL MICROPLATE
DOMINO
PN: 186009597

Fisherbrand™ 1 mL 96-well U-bottom DeepWell™ microplate



Manufacturer:
Fisher Scientific

Part number:
11381555

1-channel pipettes					
10µL	120µL	300µL	1000µL	5mL	10mL
✓	✓	✓	✓	✓	300

8-channel pipettes			
10µL	120µL	300µL	1200µL
✓	✓	✓	✓



DEEPWELL MICROPLATE
DOMINO
PN: 186009597

ILS, 12-channel reagent reservoir



Manufacturer:
Irish Life Sciences

Part number:
Res12-351

1-channel pipettes					
10 μ L	120 μ L	300 μ L	1000 μ L	5mL	10mL
✓	✓	✓	✓	✓	✓

8-channel pipettes			
10 μ L	120 μ L	300 μ L	1200 μ L
6 500	✓	✓	✓



DEEPWELL MICROPLATE
DOMINO
PN: 186009597

KingFisher 96-deep well V-bottom plate



Manufacturer:
Thermo Scientific

Part number:
95040450



1-channel pipettes					
10 μ L	120 μ L	300 μ L	1000 μ L	5mL	10mL
✓	✓	✓	✓	700	1 300

8-channel pipettes			
10 μ L	120 μ L	300 μ L	1200 μ L
500	✓	✓	✓



DEEPWELL MICROPLATE
DOMINO
PN: 186009597

MagNA Pure 96 processing cartridge



Manufacturer:
Roche

Part number:
06241603001

1-channel pipettes					
10 μ L	120 μ L	300 μ L	1000 μ L	5mL	10mL
✓	✓	✓	500	1 300	1 700

8-channel pipettes			
10 μ L	120 μ L	300 μ L	1200 μ L
1 500	1 000	500	✓



DEEPWELL MICROPLATE
DOMINO
PN: 186009597

Matrix 1.0 mL Deepwell Storage Blocks



Manufacturer:
Thermo Scientific

Part number:
4211-11

1-channel pipettes					
10 μ L	120 μ L	300 μ L	1000 μ L	5mL	10mL
✓	✓	✓	500	400	600

8-channel pipettes			
10 μ L	120 μ L	300 μ L	1200 μ L
200	✓	✓	✓



DEEPWELL MICROPLATE
DOMINO
PN: 186009597

Nunc™ 1.3 mL 96-DeepWell™ plate



Manufacturer:
Thermo Scientific

Part number:
260251



1-channel pipettes

10µL	120µL	300µL	1000µL	5mL	10mL
✓	✓	✓	✓	✓	✓

8-channel pipettes

10µL	120µL	300µL	1200µL
✓	✓	✓	✓



DEEPWELL MICROPLATE
DOMINO
PN: 186009597

Nunc™ 2 mL 96-DeepWell™ plate



Manufacturer:
Thermo Scientific

Part number:
278743



1-channel pipettes					
10µL	120µL	300µL	1000µL	5mL	10mL
✓	✓	✓	✓	500	1 200

8-channel pipettes			
10µL	120µL	300µL	1200µL
500	✓	✓	✓



DEEPWELL MICROPLATE
DOMINO
PN: 186009597

Porvair, 2 mL 96-deep well U-bottom plate



Manufacturer:
Porvair Sciences

Part number:
219020



1-channel pipettes					
10 μ L	120 μ L	300 μ L	1000 μ L	5mL	10mL
✓	✓	✓	✓	1 000	1 500

8-channel pipettes			
10 μ L	120 μ L	300 μ L	1200 μ L
✓	✓	✓	✓



DEEPWELL MICROPLATE
DOMINO
PN: 186009597

SAFE[®] 2D/1D XLX 2000 external thread tube in 48x rack



Manufacturer:

LVL technologies

Part number:

2DSC-X20-BL-NS-SLP-L

1-channel pipettes					
10 μ L	120 μ L	300 μ L	1000 μ L	5mL	10mL
✓	✓	✓	✓	500	1 000

8-channel pipettes			
10 μ L	120 μ L	300 μ L	1200 μ L
✗	✗	✗	✗



DEEPWELL MICROPLATE
DOMINO
PN: 186009597

Riplate® Medio 1mL Deepwell Plate



Manufacturer:
Carl Roth

Part number:
TC22.1

1-channel pipettes					
10µL	120µL	300µL	1000µL	5mL	10mL
✓	✓	✓	✓	✓	✓

8-channel pipettes			
10µL	120µL	300µL	1200µL
450	✓	✓	✓



DEEPWELL MICROPLATE
DOMINO
PN: 186009597

Riplate® 2mL Deepwell Plate



Manufacturer:
Carl Roth

Part number:
EN07.1

1-channel pipettes					
10µL	120µL	300µL	1000µL	5mL	10mL
✓	✓	✓	✓	800	1 200

8-channel pipettes			
10µL	120µL	300µL	1200µL
600	✓	✓	✓



DEEPWELL MICROPLATE
DOMINO
PN: 186009597

SAFE® LX 1000 2D external thread tube in SBS 96x rack



Manufacturer:
LVL technologies

Part number:
4C-X10-BL-AW-B-L

1-channel pipettes					
10µL	120µL	300µL	1000µL	5mL	10mL
✓	150	150	600	700	800

8-channel pipettes			
10µL	120µL	300µL	1200µL
400	150	150	150



DEEPWELL MICROPLATE
DOMINO
PN: 186009597

Sartorius, 24-deep well V-bottom plate



Manufacturer:
Sartorius

Part number:
A-0038



1-channel pipettes					
10 μ L	120 μ L	300 μ L	1000 μ L	5mL	10mL
✓	✓	✓	✓	✓	✓

8-channel pipettes			
10 μ L	120 μ L	300 μ L	1200 μ L
✗	✗	✗	✗



DEEPWELL MICROPLATE
DOMINO
PN: 186009597

Thermo Scientific™ 100 mL reagent reservoir

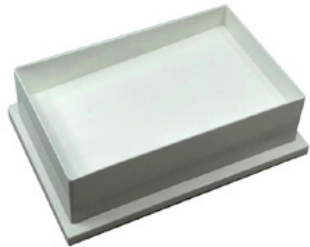

Manufacturer:
Thermo Scientific

Part number:
9510047

1-channel pipettes					
10 μ L	120 μ L	300 μ L	1000 μ L	5mL	10mL
✓	✓	✓	✓	✓	✓

8-channel pipettes			
10 μ L	120 μ L	300 μ L	1200 μ L
✓	✓	✓	✓



DEEPWELL MICROPLATE
DOMINO
PN: 186009597

Valita® Titer plate



Manufacturer:
ValitaCell

Part number:
VAL003

1-channel pipettes					
10µL	120µL	300µL	1000µL	5mL	10mL
✓	✓	✓	✓	✓	✓

8-channel pipettes			
10µL	120µL	300µL	1200µL
✓	✓	✓	✓



DEEPWELL MICROPLATE
DOMINO
PN: 186009597

Waters 2 mL 96-square well collection plate, cut corner A1/H1



SEE THIS CONSUMABLE
ON OUR E-SHOP

Manufacturer:
Waters

Part number:
WAT058958

1-channel pipettes					
10 μ L	120 μ L	300 μ L	1000 μ L	5mL	10mL
✓	✓	✓	✓	300	850

8-channel pipettes			
10 μ L	120 μ L	300 μ L	1200 μ L
✓	✓	✓	✓



DEEPWELL MICROPLATE
DOMINO
PN: 186009597

Waters 2 mL 96-square well collection plate, cut corner H1



SEE THIS CONSUMABLE
ON OUR E-SHOP

Manufacturer:
Waters

Part number:
186002482



1-channel pipettes					
10µL	120µL	300µL	1000µL	5mL	10mL
✓	✓	✓	✓	300	850

8-channel pipettes			
10µL	120µL	300µL	1200µL
✓	✓	✓	✓



DEEPWELL MICROPLATE
DOMINO
PN: 186009597

Waters 10 mL 24-square well collection plate



SEE THIS CONSUMABLE
ON OUR E-SHOP

Manufacturer:
Waters Corporation

Part number:
186005586



1-channel pipettes					
10 μ L	120 μ L	300 μ L	1000 μ L	5mL	10mL
✓	✓	✓	✓	✓	✓

8-channel pipettes			
10 μ L	120 μ L	300 μ L	1200 μ L
✗	✗	✗	✗



DEEPWELL MICROPLATE
DOMINO
PN: 186009597

Waters 350 μ L 96-square well collection plate

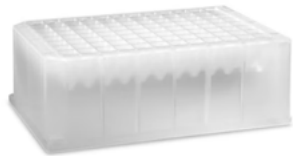

SEE THIS CONSUMABLE
ON OUR E-SHOP

Manufacturer:
Waters Corporation

Part number:
WAT058943

1-channel pipettes					
10 μ L	120 μ L	300 μ L	1000 μ L	5mL	10mL
✓	✓	✓	✓	⚠	⚠

8-channel pipettes			
10 μ L	120 μ L	300 μ L	1200 μ L
✓	✓	✓	✓



DEEPWELL MICROPLATE
DOMINO
PN: 186009597

Waters 700 μ L 96-round well collection plate



SEE THIS CONSUMABLE
ON OUR E-SHOP

Manufacturer:
Waters

Part number:
186005837



1-channel pipettes					
10 μ L	120 μ L	300 μ L	1000 μ L	5mL	10mL
✓	✓	✓	100	100	

8-channel pipettes			
10 μ L	120 μ L	300 μ L	1200 μ L
200	✓	✓	✓



DEEPWELL MICROPLATE
DOMINO
PN: 186009597

Waters 800 μ L 96-round well collection plate



SEE THIS CONSUMABLE
ON OUR E-SHOP

Manufacturer:
Waters Corporation

Part number:
186002481



1-channel pipettes					
10 μ L	120 μ L	300 μ L	1000 μ L	5mL	10mL
✓	✓	✓	50	200	400

8-channel pipettes			
10 μ L	120 μ L	300 μ L	1200 μ L
200	✓	✓	✓



DEEPWELL MICROPLATE
DOMINO
PN: 186009597

Waters QuanRecovery™ 700 µL 96-well plate



SEE THIS CONSUMABLE
ON OUR E-SHOP

Manufacturer:
Waters

Part number:
186009185



1-channel pipettes					
10µL	120µL	300µL	1000µL	5mL	10mL
✓	✓	✓	50	200	400

8-channel pipettes			
10µL	120µL	300µL	1200µL
200	✓	✓	✓



DEEPPWELL MICROPLATE
DOMINO
PN: 186009597

WebSeal 2 mL 96-deep well U-bottom plate



Manufacturer:
Thermo Scientific

Part number:
60180-P104



1-channel pipettes					
10 μ L	120 μ L	300 μ L	1000 μ L	5mL	10mL
✓	✓	✓	✓	1 000	1 000

8-channel pipettes			
10 μ L	120 μ L	300 μ L	1200 μ L
✓	✓	✓	✓



DEEPWELL MICROPLATE
DOMINO
PN: 186009597

Whatman® 96 wells, 2 mL uniplate



Manufacturer:
Whatman

Part number:
7701-5200

1-channel pipettes					
10µL	120µL	300µL	1000µL	5mL	10mL
✓	✓	✓	✓	500	1 000

8-channel pipettes			
10µL	120µL	300µL	1200µL
600	✓	✓	✓



DEERWELL MICROPLATE
DOMINO
PN: 186009597

WHEATON® 500 µL 96-well U-bottom medium µLplate



Manufacturer:
DWK Life Sciences

Part number:
07-2100-B

1-channel pipettes					
10µL	120µL	300µL	1000µL	5mL	10mL
✓	✓	✓	250	🚰	✗

8-channel pipettes			
10µL	120µL	300µL	1200µL
✓	✓	✓	✓



DEEPWELL MICROPLATE
DOMINO
PN: 186009597

Zeba™ Spin Desalting Plate



Manufacturer:
Thermo Scientific

Part number:
A57768

1-channel pipettes					
10µL	120µL	300µL	1000µL	5mL	10mL
✓	✓	✓	200	150	300

8-channel pipettes			
10µL	120µL	300µL	1200µL
150	✓	✓	✓



DEERWELL MICROPLATE
DOMINO
PN: 186009597

Ordering product number

186009596

OneLab reference: [218.2901]

STORAGE PLATE DOMINO



The Storage Plate Domino is specifically designed to directly hold certain types of deepwell plates but also racks of tubes and vials used for sample and reagent storage.

**SEE THIS DOMINO
ON OUR E-SHOP**

1.4mL Nova Biostorage tube into Matrix™ 2D rack



Manufacturer:
Thermo Scientific

Part number:
MP226RP

1-channel pipettes					
10µL	120µL	300µL	1000µL	5mL	10mL
✓	50	✓	600	600	800

8-channel pipettes			
10µL	120µL	300µL	1200µL
250	50	✓	✓



STORAGE PLATE
DOMINO
PN: 186009596

4 mL aluminum 24-well reaction block



Manufacturer:
Analytical Sales
& Services, Inc.

Part number:
24015

1-channel pipettes					
10 μ L	120 μ L	300 μ L	1000 μ L	5mL	10mL
✓	✓	✓	✓	2 500	🧪

8-channel pipettes			
10 μ L	120 μ L	300 μ L	1200 μ L
✗	✗	✗	✗



STORAGE PLATE
DOMINO
PN: 186009596

96-well photoredox block assembly



Manufacturer:
Analytical Sales
& Services, Inc.

Part number:
96973

1-channel pipettes					
10 μ L	120 μ L	300 μ L	1000 μ L	5mL	10mL
200	✓	✓	400	400	600

8-channel pipettes			
10 μ L	120 μ L	300 μ L	1200 μ L
200	✓	✓	✓



STORAGE PLATE
DOMINO
PN: 186009596

Abgene™ 2.2mL 96-well Deepwell Sample Plate



Manufacturer:
Thermo Scientific

Part number:
AB-0661

1-channel pipettes					
10µL	120µL	300µL	1000µL	5mL	10mL
✓	✓	✓	✓	✓	✓

8-channel pipettes			
10µL	120µL	300µL	1200µL
600	✓	✓	✓



STORAGE PLATE
DOMINO
PN: 186009596

Abgene™ 96 Well 1.2mL Deepwell Plate



Manufacturer:
Thermo Scientific

Part number:
AB1127

1-channel pipettes					
10µL	120µL	300µL	1000µL	5mL	10mL
✓	✓	✓	800	✓	✓

8-channel pipettes			
10µL	120µL	300µL	1200µL
300	✓	✓	200



STORAGE PLATE
DOMINO
PN: 186009596

Agilent 2 mL 12x32mm screw-top vial in 54x vial plate



Manufacturer:
Agilent Technologies

Part number:
5182-0715

1-channel pipettes					
10 μ L	120 μ L	300 μ L	1000 μ L	5mL	10mL
✓	✓	✓	1 000	🧪	🧪

8-channel pipettes			
10 μ L	120 μ L	300 μ L	1200 μ L
✗	✗	✗	✗



STORAGE PLATE
DOMINO
PN: 186009596

Agilent 96-well plate, 2.2 mL



Manufacturer:
Agilent Technologies

Part number:
5043-9300



1-channel pipettes					
10 μ L	120 μ L	300 μ L	1000 μ L	5mL	10mL
✓	✓	✓	✓	300	750

8-channel pipettes			
10 μ L	120 μ L	300 μ L	1200 μ L
300	✓	✓	✓



STORAGE PLATE
DOMINO
PN: 186009596

ArcticWhite, 73 mL 4-column reservoir



Manufacturer:
ArcticWhite LLC

Part number:
AWLS-S30051

1-channel pipettes					
10 μ L	120 μ L	300 μ L	1000 μ L	5mL	10mL
✓	✓	✓	✓	✓	✓

8-channel pipettes			
10 μ L	120 μ L	300 μ L	1200 μ L
✓	✓	✓	✓



STORAGE PLATE
DOMINO
PN: 186009596

Azenta 0.9 mL external thread dual-coded tube in 96x rack



Manufacturer:
Azenta Life Sciences

Part number:
68-1001-11

1-channel pipettes					
10 μ L	120 μ L	300 μ L	1000 μ L	5mL	10mL
✓	✓	✓	600	🧪	🧪

8-channel pipettes			
10 μ L	120 μ L	300 μ L	1200 μ L
500	✓	✓	✓



STORAGE PLATE
DOMINO
PN: 186009596

Azenta 1 mL external thread tri-coded tube in 96x rack



Manufacturer:
Azenta Life Sciences

Part number:
68-1003-01

1-channel pipettes					
10 μ L	120 μ L	300 μ L	1000 μ L	5mL	10mL
✓	200	200	700	700	

8-channel pipettes			
10 μ L	120 μ L	300 μ L	1200 μ L
600	200	200	200



STORAGE PLATE
DOMINO
PN: 186009596

Azenta 1.5 mL external thread 2D tube in 48x rack



Manufacturer:
Azenta Life Sciences

Part number:
65-7667

1-channel pipettes					
10 μ L	120 μ L	300 μ L	1000 μ L	5mL	10mL
✓	✓	✓	✓	✓	✓

8-channel pipettes			
10 μ L	120 μ L	300 μ L	1200 μ L
✗	✗	✗	✗



STORAGE PLATE
DOMINO
PN: 186009596

Azenta 1.9 mL external thread 2D tube in 48x rack



Manufacturer:
Azenta Life Sciences

Part number:
65-7647

1-channel pipettes					
10 μ L	120 μ L	300 μ L	1000 μ L	5mL	10mL
✓	✓	✓	✓	✓	300

8-channel pipettes			
10 μ L	120 μ L	300 μ L	1200 μ L
✗	✗	✗	✗



STORAGE PLATE
DOMINO
PN: 186009596

Azenta 3.8 mL external thread tri-coded tube in 48x rack



Manufacturer:
Azenta Life Sciences

Part number:
65-7515

1-channel pipettes					
10 μ L	120 μ L	300 μ L	1000 μ L	5mL	10mL
✓	✓	✓	200	2 900	3 800

8-channel pipettes			
10 μ L	120 μ L	300 μ L	1200 μ L
✗	✗	✗	✗



STORAGE PLATE
DOMINO
PN: 186009596

Eppendorf 0.5 mL 96-deep well protein LoBind® plate, yellow frame



Manufacturer:
Eppendorf

Part number:
0030504119



1-channel pipettes					
10µL	120µL	300µL	1000µL	5mL	10mL
✓	✓	✓	✓	✓	300

8-channel pipettes			
10µL	120µL	300µL	1200µL
300	✓	✓	✓



STORAGE PLATE
DOMINO
PN: 186009596

Eppendorf 2 mL 96-square deep well plate, yellow frame



Manufacturer:
Eppendorf

Part number:
0030501314



1-channel pipettes					
10 μ L	120 μ L	300 μ L	1000 μ L	5mL	10mL
✓	✓	✓	✓	700	1 300

8-channel pipettes			
10 μ L	120 μ L	300 μ L	1200 μ L
500	✓	✓	✓



STORAGE PLATE
DOMINO
PN: 186009596

Eppendorf™ Deepwell™ Plates 96



Manufacturer:
Eppendorf

Part number:
951033308

1-channel pipettes					
10µL	120µL	300µL	1000µL	5mL	10mL
✓	✓	✓	500	500	700

8-channel pipettes			
10µL	120µL	300µL	1200µL
300	✓	✓	✓



STORAGE PLATE
DOMINO
PN: 186009596

FluidX 1.9 mL external thread 2D cryotube in 48x rack



Manufacturer:
Azenta Life Sciences

Part number:
65-7643

1-channel pipettes					
10 μ L	120 μ L	300 μ L	1000 μ L	5mL	10mL
✓	✓	✓	✓	✓	500

8-channel pipettes			
10 μ L	120 μ L	300 μ L	1200 μ L
✗	✗	✗	✗



STORAGE PLATE
DOMINO
PN: 186009596

Matrix™ 0.5 mL V-bottom 2D screw-top tube in 96x rack



Manufacturer:
Thermo Scientific

Part number:
3744-BR

1-channel pipettes					
10µL	120µL	300µL	1000µL	5mL	10mL
✓	✓	✓	300	300	400

8-channel pipettes			
10µL	120µL	300µL	1200µL
300	✓	✓	✓



STORAGE PLATE
DOMINO
PN: 186009596

Matrix™ 0.75 mL blank storage tube in 96x rack



Manufacturer:
Thermo Scientific

Part number:
4272

1-channel pipettes					
10µL	120µL	300µL	1000µL	5mL	10mL
✓	✓	✓	300	🚫	🚫

8-channel pipettes			
10µL	120µL	300µL	1200µL
200	✓	✓	✓



STORAGE PLATE
DOMINO
PN: 186009596

Matrix 1.0 mL Deepwell Storage Blocks



Manufacturer:
Thermo Scientific

Part number:
4211-11

1-channel pipettes					
10 μ L	120 μ L	300 μ L	1000 μ L	5mL	10mL
✓	✓	✓	500	400	600

8-channel pipettes			
10 μ L	120 μ L	300 μ L	1200 μ L
200	✓	✓	✓



STORAGE PLATE
DOMINO
PN: 186009596

Matrix™ 1 mL V-bottom 2D screw-top tube in 96x rack

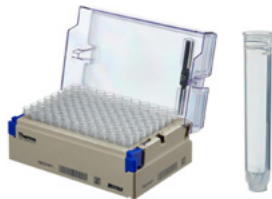

Manufacturer:
Thermo Scientific

Part number:
3741-BR

1-channel pipettes					
10µL	120µL	300µL	1000µL	5mL	10mL
✓	30	20	600	600	850

8-channel pipettes			
10µL	120µL	300µL	1200µL
500	30	20	30



STORAGE PLATE
DOMINO
PN: 186009596

Matrix™ 1.4 mL 2D barcoded open-top tube in 96x rack



Manufacturer:
Thermo Scientific

Part number:
3791

1-channel pipettes					
10µL	120µL	300µL	1000µL	5mL	10mL
✓	70	50	700	700	9 004

8-channel pipettes			
10µL	120µL	300µL	1200µL
300	70	50	✓



STORAGE PLATE
DOMINO
PN: 186009596

Matrix™ 1.4 mL alphanumeric storage tube in 96x rack



Manufacturer:
Thermo Scientific

Part number:
4251

1-channel pipettes

10µL	120µL	300µL	1000µL	5mL	10mL
✓	100	100	650	🚫	🚫

8-channel pipettes

10µL	120µL	300µL	1200µL
500	100	100	✓



STORAGE PLATE
DOMINO
PN: 186009596

Matrix™ ScrewTop Tri-coded Tubes into 96 positions rack



Manufacturer:
Thermo Scientific

Part number:
3742-WP1D-BR



Compatible with
Microplate
Gripper

1-channel pipettes					
10µL	120µL	300µL	1000µL	5mL	10mL
✓	✓	✓	650	550	800

8-channel pipettes			
10µL	120µL	300µL	1200µL
✓	✓	✓	40





STORAGE PLATE
DOMINO
PN: 186009596

Milian, 1.2 mL transfer tube in Hitplate™ 96x rack



Manufacturer:
Milian

Part number:
605300

1-channel pipettes					
10µL	120µL	300µL	1000µL	5mL	10mL
✓	✓	100	600		

8-channel pipettes			
10µL	120µL	300µL	1200µL
✓	✓	100	700



STORAGE PLATE
DOMINO
PN: 186009596

Riplate® Medio 1mL Deepwell Plate



Manufacturer:
Carl Roth

Part number:
TC22.1

1-channel pipettes					
10µL	120µL	300µL	1000µL	5mL	10mL
✓	✓	✓	✓	✓	✓

8-channel pipettes			
10µL	120µL	300µL	1200µL
450	✓	✓	✓



STORAGE PLATE
DOMINO
PN: 186009596

Riplate® 2mL Deepwell Plate



Manufacturer:
Carl Roth

Part number:
EN07.1

1-channel pipettes					
10µL	120µL	300µL	1000µL	5mL	10mL
✓	✓	✓	✓	800	1 200

8-channel pipettes			
10µL	120µL	300µL	1200µL
600	✓	✓	✓



STORAGE PLATE
DOMINO
PN: 186009596

Waters 2 mL 96-square well collection plate, cut corner A1/H1



SEE THIS CONSUMABLE
ON OUR E-SHOP

Manufacturer:
Waters

Part number:
WAT058958

1-channel pipettes					
10 μ L	120 μ L	300 μ L	1000 μ L	5mL	10mL
✓	✓	✓	✓	300	850

8-channel pipettes			
10 μ L	120 μ L	300 μ L	1200 μ L
✓	✓	✓	✓



STORAGE PLATE
DOMINO
PN: 186009596

Waters 2 mL 96-square well collection plate, cut corner H1



SEE THIS CONSUMABLE
ON OUR E-SHOP

Manufacturer:
Waters

Part number:
186002482



1-channel pipettes					
10 μ L	120 μ L	300 μ L	1000 μ L	5mL	10mL
✓	✓	✓	✓	300	850

8-channel pipettes			
10 μ L	120 μ L	300 μ L	1200 μ L
✓	✓	✓	✓



STORAGE PLATE
DOMINO
PN: 186009596

Waters 700 μ L 96-round well collection plate



SEE THIS CONSUMABLE
ON OUR E-SHOP

Manufacturer:
Waters

Part number:
186005837



1-channel pipettes					
10 μ L	120 μ L	300 μ L	1000 μ L	5mL	10mL
✓	✓	✓	100	100	

8-channel pipettes			
10 μ L	120 μ L	300 μ L	1200 μ L
200	✓	✓	✓



STORAGE PLATE
DOMINO
PN: 186009596

Waters 800 μ L 96-round well collection plate



**SEE THIS CONSUMABLE
ON OUR E-SHOP**

Manufacturer:
Waters

Part number:
186002481



1-channel pipettes					
10 μ L	120 μ L	300 μ L	1000 μ L	5mL	10mL
✓	✓	✓	50	200	400

8-channel pipettes			
10 μ L	120 μ L	300 μ L	1200 μ L
200	✓	✓	✓



**STORAGE PLATE
DOMINO
PN: 186009596**

Waters GlycoWorks™ 600 µL tubes in 96x plate



**SEE THIS CONSUMABLE
ON OUR E-SHOP**

Manufacturer:
Waters

Part number:
186007988-3



1-channel pipettes					
10µL	120µL	300µL	1000µL	5mL	10mL
120	✓	✓	300	300	

8-channel pipettes			
10µL	120µL	300µL	1200µL
120	✓	✓	300



STORAGE PLATE
DOMINO
PN: 186009596

Waters QuanRecovery™ 700 µL 96-well plate



**SEE THIS CONSUMABLE
ON OUR E-SHOP**

Manufacturer:
Waters

Part number:
186009185



1-channel pipettes					
10µL	120µL	300µL	1000µL	5mL	10mL
✓	✓	✓	50	200	400

8-channel pipettes			
10µL	120µL	300µL	1200µL
200	✓	✓	✓



STORAGE PLATE
DOMINO
PN: 186009596

Whatman® 96 wells, 2 mL uniplate



Manufacturer:
Whatman

Part number:
7701-5200

1-channel pipettes					
10µL	120µL	300µL	1000µL	5mL	10mL
✓	✓	✓	✓	500	1 000

8-channel pipettes			
10µL	120µL	300µL	1200µL
600	✓	✓	✓



STORAGE PLATE
DOMINO
PN: 186009596

Zeba™ Spin Desalting Plate



Manufacturer:
Thermo Scientific

Part number:
A57768

1-channel pipettes					
10µL	120µL	300µL	1000µL	5mL	10mL
✓	✓	✓	200	100	300

8-channel pipettes			
10µL	120µL	300µL	1200µL
150	✓	✓	✓



STORAGE PLATE
DOMINO
PN: 186009596

Ordering product number

186010088

OneLab reference: [218.2212]

96-PCR PLATE DOMINO



The 96-PCR Plate Domino is designed to hold an array of PCR-type plates with or without skirts thanks to its snug-fitting 96x format pockets.

**SEE THIS DOMINO
ON OUR E-SHOP**

Axygen® 96-well PCR white microplate



Manufacturer:
Starlab

Part number:
PCR-96-LC480-W-NF

1-channel pipettes					
10µL	120µL	300µL	1000µL	5mL	10mL
✓	✓	✓	✓	40	60

8-channel pipettes			
10µL	120µL	300µL	1200µL
✓	✓	✓	✓



96-PCR PLATE DOMINO
PN: 186010088

Eppendorf twin.tec® 96-well semi-skirted PCR plate



Manufacturer:
Eppendorf

Part number:
0030128575

1-channel pipettes					
10µL	120µL	300µL	1000µL	5mL	10mL
✓	✓	✓	✓	✗	✗

8-channel pipettes			
10µL	120µL	300µL	1200µL
✓	✓	✓	✓



96-PCR PLATE DOMINO
PN: 186010088

FrameStar® break-a-way PCR plate in 96x FrameStrip® adapter

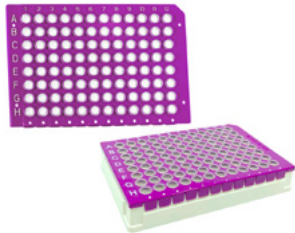

Manufacturer:
Azenta Life Sciences

Part number:
4ti-1000/P

1-channel pipettes					
10µL	120µL	300µL	1000µL	5mL	10mL
✓	✓	✓	✓	✗	✗

8-channel pipettes			
10µL	120µL	300µL	1200µL
✓	✓	✓	✓



96-PCR PLATE DOMINO
PN: 186010088

FrameStrip® 8-well PCR tube strip in 96x FrameStrip® adapter

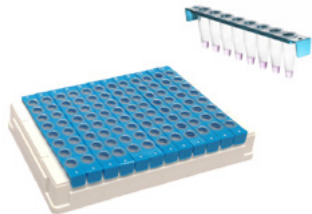

Manufacturer:
Azenta Life Sciences

Part number:
4ti-0786/B

1-channel pipettes					
10µL	120µL	300µL	1000µL	5mL	10mL
✓	✓	✓	✓	⚠	⚠

8-channel pipettes			
10µL	120µL	300µL	1200µL
✓	✓	✓	✓



96-PCR PLATE DOMINO
PN: 186010088

MicroAmp™ 0.2 mL Fast Optical 96-well semi-skirted reaction plate



Manufacturer:
Thermo Scientific

Part number:
4346907

1-channel pipettes					
10µL	120µL	300µL	1000µL	5mL	10mL
✓	✓	✓	✓	⚠	⚠

8-channel pipettes			
10µL	120µL	300µL	1200µL
✓	✓	✓	✓



96-PCR PLATE DOMINO
PN: 186010088

MicroAmp™ 0.3 mL optical 96-well semi-skirted reaction plate



Manufacturer:
Applied Biosystems

Part number:
N8010560

1-channel pipettes					
10µL	120µL	300µL	1000µL	5mL	10mL
✓	✓	✓	100	🚫	🚫

8-channel pipettes			
10µL	120µL	300µL	1200µL
✓	✓	✓	✓



96-PCR PLATE DOMINO
PN: 186010088

MicroAmp™ EnduraPlate™ 0.3 mL optical 96-well reaction plate w/ barcode



Manufacturer:
Applied Biosystems

Part number:
4483354

1-channel pipettes					
10µL	120µL	300µL	1000µL	5mL	10mL
✓	✓	✓	✓	⚠	⚠

8-channel pipettes			
10µL	120µL	300µL	1200µL
✓	✓	✓	✓



96-PCR PLATE DOMINO
PN: 186010088

MicroAmp™ EnduraPlate™ Optical 96-Well Fast Clear Reaction Plates with Barcode



Manufacturer:
Thermo Scientific

Part number:
4483485

1-channel pipettes					
10µL	120µL	300µL	1000µL	5mL	10mL
✓	✓	✓	✓	20	30

8-channel pipettes			
10µL	120µL	300µL	1200µL
✓	✓	✓	✓



96-PCR PLATE DOMINO
PN: 186010088

Multiply[®] 96-well non-skirted PCR plate



Manufacturer:
Sarstedt

Part number:
72.1978

1-channel pipettes					
10 μ L	120 μ L	300 μ L	1000 μ L	5mL	10mL
✓	✓	✓	✓	✗	✗

8-channel pipettes			
10 μ L	120 μ L	300 μ L	1200 μ L
✓	✓	✓	✓



96-PCR PLATE DOMINO
PN: 186010088

Roche LightCycler[®] 480 white 96-well plate



Manufacturer:
Roche

Part number:
04729692001

1-channel pipettes					
10µL	120µL	300µL	1000µL	5mL	10mL
✓	✓	✓	✓	✗	✗

8-channel pipettes			
10µL	120µL	300µL	1200µL
✓	✓	✓	✓



96-PCR PLATE DOMINO
PN: 186010088

TempAssure® 0.2 mL 8-tube strip in Vari-Plate™ 96x frame



Manufacturer:
USA Scientific, Inc.

Part number:
1402-2500

1-channel pipettes					
10µL	120µL	300µL	1000µL	5mL	10mL
✓	✓	✓	100	🚫	🚫

8-channel pipettes			
10µL	120µL	300µL	1200µL
✓	✓	✓	✓

IMPORTANT

When setting up the TempAssure® 0.2 mL 8-tube strip(s) in Vari-Plate™ 96x frame into the 96-PCR Plate Domino, it is recommended to first place the empty frame in the Domino, ensuring it is firmly inserted into the support.

Then, the TempAssure® 0.2 mL 8-tube strip(s) can be individually loaded into any of the 12x column slots of the frame as required and in a clean way (using gloves), making sure they are properly inserted.



96-PCR PLATE DOMINO
PN: 186010088

Thermo Scientific™ 96-well non-skirted PCR plate



Manufacturer:
Thermo Scientific

Part number:
AB0600

1-channel pipettes					
10 μ L	120 μ L	300 μ L	1000 μ L	5mL	10mL
✓	✓	✓	✓	✗	✗

8-channel pipettes			
10 μ L	120 μ L	300 μ L	1200 μ L
✓	✓	✓	✓



96-PCR PLATE DOMINO
PN: 186010088

Thermo Scientific™ Armadillo™ 96-well PCR strip plate



Manufacturer:
Thermo Scientific

Part number:
AB2796

1-channel pipettes					
10 μ L	120 μ L	300 μ L	1000 μ L	5mL	10mL
✓	✓	✓	✓	⚠	⚠

8-channel pipettes			
10 μ L	120 μ L	300 μ L	1200 μ L
✓	✓	✓	✓



96-PCR PLATE DOMINO
PN: 186010088

Ordering product number

186010325

OneLab reference: [218.5191]

PCR CARTRIDGE DOMINO



The PCR Cartridge Domino is designed to securely hold a specific PCR-type plate in place during automated pipetting steps where tips will get «stuck» inside the consumable due to the design of the plate. This Domino design ensures that the plate doesn't move during the pipetting steps and can't get inadvertently picked up by the Andrew+ instrument after pipetting. Note: the «dispense from the bottom» option must be selected in OneLab when working with this consumable.

**SEE THIS DOMINO
ON OUR E-SHOP**

QX ONE ddPCR GCR96 cartridge plate



Manufacturer:
Bio-Rad Laboratories

Part number:
12006858

1-channel pipettes					
10 μ L	120 μ L	300 μ L	1000 μ L	5mL	10mL
✓	✓	✓	🚫	🚫	🚫

8-channel pipettes			
10 μ L	120 μ L	300 μ L	1200 μ L
✓	✓	✓	🚫



PCR CARTRIDGE DOMINO
PN: 186010325

Ordering product number

186010172

OneLab reference: [218.3361]

WES AND JESS PLATE DOMINO



The Wes and Jess Plate Domino is specifically designed to hold the plates bearing the same name.

**SEE THIS DOMINO
ON OUR E-SHOP**

ProteinSimple, Wes/Jess plate



Manufacturer:
ProteinSimple

Part number:
PS-PP03

1-channel pipettes					
10 μ L	120 μ L	300 μ L	1000 μ L	5mL	10mL
✓	✓	✓	✓	⚠	⚠

8-channel pipettes			
10 μ L	120 μ L	300 μ L	1200 μ L
✗	✗	✗	✗



**WES AND JESS
PLATE DOMINO**
PN: 186010172

Ordering product number

186010284

OneLab reference: [218.4341]

NON-ANSI PLATE DOMINO



The Non-ANSI Plate Domino is specifically designed to hold plates that are not compliant with ANSI standard microplate footprint dimensions.

[SEE THIS DOMINO
ON OUR E-SHOP](#)

Nunc™ 0.3 mL 96-MicroWell™ plate



Manufacturer:
Thermo Scientific

Part number:
442587

1-channel pipettes					
10µL	120µL	300µL	1000µL	5mL	10mL
✓	✓	✓	✓	⚠	⚠

8-channel pipettes			
10µL	120µL	300µL	1200µL
✓	✓	✓	✓



NON-ANSI
PLATE DOMINO
PN: 186010284

Ordering product number

186010306

OneLab reference: [218.5611]

LANDING PAD MICROPLATE DOMINO



The Landing Pad Microplate Domino is a specifically engineered Microplate Domino that is designed to allow robotic arms other than Andrew+ to grab plates found inside it from their «long edge».

[SEE THIS DOMINO
ON OUR E-SHOP](#)

Greiner, 96-well PS F-bottom clear microplate



Manufacturer:
Greiner Bio-One

Part number:
655101



1-channel pipettes					
10 μ L	120 μ L	300 μ L	1000 μ L	5mL	10mL
✓	✓	✓	✓	⚠	⚠

8-channel pipettes			
10 μ L	120 μ L	300 μ L	1200 μ L
✓	✓	✓	✓



LANDING PAD
MICROPLATE DOMINO
PN: 186010306

Ordering product number

186010310

OneLab reference: [218.5251]

100-WELL HONEYCOMB PLATE DOMINO

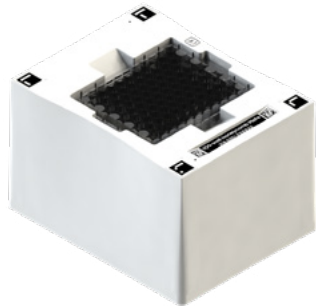

The 100-well HoneyComb Plate Domino is specifically designed to hold non-standard, small-format 100-well plates that have a «honeycomb» configuration where the wells are not aligned.

[SEE THIS DOMINO
ON OUR E-SHOP](#)

Bioscreen Sterile Honeycomb Plates



Manufacturer:
Thermo Scientific

Part number:
9502550

1-channel pipettes					
10 μ L	120 μ L	300 μ L	1000 μ L	5mL	10mL
✓	✓	✓	✓	✓	⚠

8-channel pipettes			
10 μ L	120 μ L	300 μ L	1200 μ L
✗	✗	✗	✗



100-WELL HONEYCOMB
PLATE DOMINO
PN: 186010310

Ordering product number

186010322

OneLab reference: [218.5371]

METALLIC OEM PLATE DOMINO



The Metallic OEM Plate Domino is a custom-designed Domino for holding up to 6 metallic reaction vessels.

**SEE THIS DOMINO
ON OUR E-SHOP**

Metallic reaction vessel in 2x3 position holder

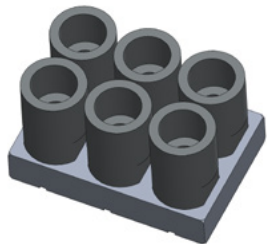

Manufacturer:
OEM

Part number:
N/A

1-channel pipettes					
10 μ L	120 μ L	300 μ L	1000 μ L	5mL	10mL
✓	✓	✓	✓	✓	✓

8-channel pipettes			
10 μ L	120 μ L	300 μ L	1200 μ L
✗	✗	✗	✗



METALLIC OEM PLATE
DOMINO
PN: 186010322

Ordering product number

186010195

OneLab reference: [218.3571]

TILTED MICROPLATE DOMINO



The Tilted Microplate Domino is designed to hold a growing array of microplates. It's lightly tilted design holds microplates in place at a small descending angle from back to front (short edge), thus minimizing dead-volumes. The Andrew+ robot detects the use of this Domino and adapts dispensing and aspirating steps accordingly, specifically choosing to dispense towards the top of the wells and aspirating from their bottom corner for optimal volume recovery.

[SEE THIS DOMINO
ON OUR E-SHOP](#)

24-well plate with glass bottom



Manufacturer:
Cellvis

Part number:
P24-1.5H-N

1-channel pipettes					
10 μ L	120 μ L	300 μ L	1000 μ L	5mL	10mL
✓	✓	✓	✓	✓	✓

8-channel pipettes			
10 μ L	120 μ L	300 μ L	1200 μ L
✗	✗	✗	✗



TILTED MICROPLATE
DOMINO
PN: 186010195

96-well plate with glass bottom



Manufacturer:
Cellvis

Part number:
P96-1.5H-N

1-channel pipettes					
10 μ L	120 μ L	300 μ L	1000 μ L	5mL	10mL
✓	✓	✓	✓	✓	✗

8-channel pipettes			
10 μ L	120 μ L	300 μ L	1200 μ L
✓	✓	✓	✓



TILTED MICROPLATE
DOMINO
PN: 186010195

CELLSTAR® 24-well cell culture plate

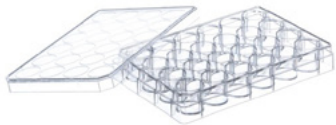

Manufacturer:
Greiner Bio-One

Part number:
662160

1-channel pipettes					
10µL	120µL	300µL	1000µL	5mL	10mL
✓	✓	✓	✓	✓	✓

8-channel pipettes			
10µL	120µL	300µL	1200µL
✗	✗	✗	✗



TILTED MICROPLATE
DOMINO
PN: 186010195

Corning® 96-well Half Area, Glass Bottom Microplate



Manufacturer:
Corning Inc.

Part number:
4580

1-channel pipettes					
10µL	120µL	300µL	1000µL	5mL	10mL
✓	✓	✓	✓	✗	✗

8-channel pipettes			
10µL	120µL	300µL	1200µL
✓	✓	✓	✓



TILTED MICROPLATE
DOMINO
PN: 186010195

Corning® CellBIND® 360 µL 96-well clear bottom black microplate



Manufacturer:
Corning Inc.

Part number:
3340

1-channel pipettes					
10µL	120µL	300µL	1000µL	5mL	10mL
✓	✓	✓	✓	⚠	⚠

8-channel pipettes			
10µL	120µL	300µL	1200µL
✓	✓	✓	✓



TILTED MICROPLATE
DOMINO
PN: 186010195

Falcon® 6-well cell culture plate, tilted wells



Manufacturer:
Corning Inc.

Part number:
353224

1-channel pipettes					
10 μ L	120 μ L	300 μ L	1000 μ L	5mL	10mL
✓	✓	✓	✓	✓	✓

8-channel pipettes			
10 μ L	120 μ L	300 μ L	1200 μ L
✗	✗	✗	✗



TILTED MICROPLATE
DOMINO
PN: 186010195

ibidi, 96-well ibiTreat black μ -Plate w/ polymer coverslip bottom



Manufacturer:
ibidi

Part number:
89626

1-channel pipettes

10 μ L	120 μ L	300 μ L	1000 μ L	5mL	10mL
✓	✓	✓	✓	✓	✓

8-channel pipettes

10 μ L	120 μ L	300 μ L	1200 μ L
✓	✓	✓	✓



TILTED MICROPLATE
DOMINO
PN: 186010195

Nunc™ Edge™ 96-well cell culture-treated microplate



Manufacturer:
Thermo Scientific

Part number:
167425

1-channel pipettes					
10µL	120µL	300µL	1000µL	5mL	10mL
✓	✓	✓	✓	⚠	⚠

8-channel pipettes			
10µL	120µL	300µL	1200µL
✓	✓	✓	✓



TILTED MICROPLATE
DOMINO
PN: 186010195

TPP 12-well tissue culture test plate

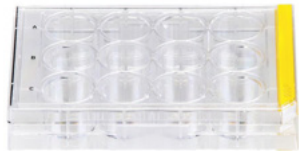

Manufacturer:
TPP AG

Part number:
92412

1-channel pipettes					
10 μ L	120 μ L	300 μ L	1000 μ L	5mL	10mL
✓	✓	✓	✓	✓	✓

8-channel pipettes			
10 μ L	120 μ L	300 μ L	1200 μ L
✗	✗	✗	✗



TILTED MICROPLATE
DOMINO
PN: 186010195

Ordering product number

186010200

OneLab reference: [218.4001]

LONG EDGE TILT DEEPWELL DOMINO



The Long Edge Tilt Domino is designed to hold a growing array of consumables used for various applications. It's lightly tilted design holds plates and reservoirs in place at a small descending angle from left to right (long edge), thus minimizing dead-volumes. The Andrew+ robot detects the use of this Domino and adapts dispensing and aspirating steps accordingly, specifically choosing to dispense towards the sides of the wells and aspirating from their bottom corner for optimal volume recovery.

[SEE THIS DOMINO
ON OUR E-SHOP](#)

ArcticWhite, 290 mL single cavity reservoir



Manufacturer:
ArcticWhite LLC

Part number:
AWLS-S30017

1-channel pipettes

10 μ L	120 μ L	300 μ L	1000 μ L	5mL	10mL
✓	✓	✓	✓	✓	✓

8-channel pipettes

10 μ L	120 μ L	300 μ L	1200 μ L
✓	✓	✓	✓



LONG EDGE TILT
DEEPWELL DOMINO
PN: 186010200

Axygen® 96 V-bottom single well reservoir



Manufacturer:
Corning Inc.

Part number:
RES-SW96-HP-SI

1-channel pipettes					
10µL	120µL	300µL	1000µL	5mL	10mL
✓	✓	✓	✓	✓	✓

8-channel pipettes			
10µL	120µL	300µL	1200µL
✓	✓	✓	✓



LONG EDGE TILT
DEEPWELL DOMINO
PN: 186010200

Ordering product number

186009613

OneLab reference: [218.2182]

8-CHANNEL PIPETTE RESERVOIR DOMINO



The 8-channel Pipette Reservoir Domino is specifically designed to hold 2x 10mL reservoirs in a single Domino location while providing minimal dead volume and 8-channel pipette compatibility.

**SEE THIS DOMINO
ON OUR E-SHOP**

INTEGRA 10 mL multichannel reservoir



Manufacturer:
INTEGRA Biosciences

Part number:
4332

1-channel pipettes					
10 μ L	120 μ L	300 μ L	1000 μ L	5mL	10mL
✓	✓	✓	✓	✓	✓

8-channel pipettes			
10 μ L	120 μ L	300 μ L	1200 μ L
1 000	✓	✓	✓



**8-CHANNEL PIPETTE
RESERVOIR DOMINO**
PN: 186009613

FOR TUBES AND VIALS

Ordering product number

186010171

OneLab reference: [218.3331]

24-WELL PHOTOREDOX BLOCK DOMINO

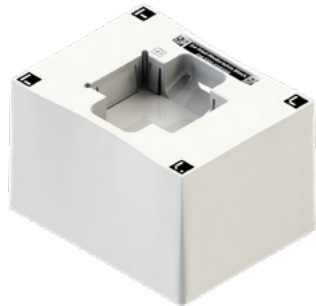

The 24-well Photoredox Block Domino is specifically designed to hold a single 24-well photoredox block assembly.

**SEE THIS DOMINO
ON OUR E-SHOP**

24-well photoredox block assembly



Manufacturer:
Analytical Sales &
Services, Inc.

Part number:
24253

1-channel pipettes					
10 μ L	120 μ L	300 μ L	1000 μ L	5mL	10mL
200	✓	✓	400	400	600

8-channel pipettes			
10 μ L	120 μ L	300 μ L	1200 μ L
✗	✗	✗	✗



24-WELL PHOTOREDOX
BLOCK DOMINO
PN: 186010171

Ordering product number

186010096

OneLab reference: [218.2331]

0.5-0.6ML MICROTUBE DOMINO



The 0.5-0.6mL Microtube Domino is designed to hold small-volume microtubes. It features a design that maintains attached caps of certain tubes in a vertical position to avoid automation collisions. It can hold up to 24 microtubes.

**SEE THIS DOMINO
ON OUR E-SHOP**

Eppendorf 0.5 mL DNA LoBind[®] microtube



Manufacturer:
Eppendorf

Part number:
0030108035

1-channel pipettes					
10 μ L	120 μ L	300 μ L	1000 μ L	5mL	10mL
✓	✓	✓	100	100	200

8-channel pipettes			
10 μ L	120 μ L	300 μ L	1200 μ L
✗	✗	✗	✗



0.5-0.6ML MICROTUBE
DOMINO
PN: 186010096

Eppendorf 0.5 mL protein LoBind® microtube



Manufacturer:
Eppendorf

Part number:
0030108094

1-channel pipettes					
10µL	120µL	300µL	1000µL	5mL	10mL
40	✓	✓	120	🧪	🧪

8-channel pipettes			
10µL	120µL	300µL	1200µL
✗	✗	✗	✗



0.5-0.6ML MICROTUBE
DOMINO
PN: 186010096

Eppendorf 0.5 mL Safe-Lock tube



Manufacturer:
Eppendorf

Part number:
0030121023

1-channel pipettes					
10 μ L	120 μ L	300 μ L	1000 μ L	5mL	10mL
40	✓	✓	120	🧪	🧪

8-channel pipettes			
10 μ L	120 μ L	300 μ L	1200 μ L
✗	✗	✗	✗



0.5-0.6ML MICROTUBE
DOMINO
PN: 186010096

Qubit™ 0.5 mL assay tube



Manufacturer:
Thermo Scientific

Part number:
Q32856

1-channel pipettes					
10µL	120µL	300µL	1000µL	5mL	10mL
30	✓	✓	200	150	300

8-channel pipettes			
10µL	120µL	300µL	1200µL
✗	✗	✗	✗



0.5-0.6ML MICROTUBE
DOMINO
PN: 186010096

Ordering product number

186009601

OneLab reference: [218.2152]

MICROTUBE DOMINO



The Microtube Domino is designed to hold a growing array of various microtube formats. It features a design that maintains attached caps of certain tubes in a vertical position to avoid automation colisions. It can hold up to 24 tubes.

[SEE THIS DOMINO
ON OUR E-SHOP](#)

2 mL Conical Skirted Microtube with Screw Cap



Manufacturer:
Sarstedt

Part number:
72.694.006

1-channel pipettes					
10 μ L	120 μ L	300 μ L	1000 μ L	5mL	10mL
✓	✓	✓	✓	500	1 000

8-channel pipettes			
10 μ L	120 μ L	300 μ L	1200 μ L
✗	✗	✗	✗



MICROTUBE DOMINO
PN: 186009601

2 mL Skirted Conical Base Screw Cap Microtube



MICROTUBE DOMINO
PN: 186009601



Manufacturer:
Sarstedt

Part number:
72.694.396

1-channel pipettes					
10 μ L	120 μ L	300 μ L	1000 μ L	5mL	10mL
✓	✓	✓	✓	700	1 100

8-channel pipettes			
10 μ L	120 μ L	300 μ L	1200 μ L
✗	✗	✗	✗

Axygen® 1.5 mL Maxymum Recovery® snaplock microtube



Manufacturer:
Corning Inc.

Part number:
MCT-150-L-C

1-channel pipettes					
10µL	120µL	300µL	1000µL	5mL	10mL
✓	✓	✓	✓	✓	600

8-channel pipettes			
10µL	120µL	300µL	1200µL
✗	✗	✗	✗



MICROTUBE DOMINO
PN: 186009601

Eppendorf 1.5 mL DNA LoBind[®] microtube



Manufacturer:
Eppendorf

Part number:
0030108051

1-channel pipettes					
10 μ L	120 μ L	300 μ L	1000 μ L	5mL	10mL
✓	✓	✓	✓	✓	600

8-channel pipettes			
10 μ L	120 μ L	300 μ L	1200 μ L
✗	✗	✗	✗



MICROTUBE DOMINO
PN: 186009601

Eppendorf 1.5 mL protein LoBind[®] microtube



Manufacturer:
Eppendorf

Part number:
0030108116

1-channel pipettes					
10 μ L	120 μ L	300 μ L	1000 μ L	5mL	10mL
✓	✓	✓	✓	✓	600

8-channel pipettes			
10 μ L	120 μ L	300 μ L	1200 μ L
✗	✗	✗	✗



MICROTUBE DOMINO
PN: 186009601

Eppendorf 1.5 mL Safe-Lock tube



Manufacturer:
Eppendorf

Part number:
0030120086

1-channel pipettes					
10 μ L	120 μ L	300 μ L	1000 μ L	5mL	10mL
✓	✓	✓	✓	✓	⚠

8-channel pipettes			
10 μ L	120 μ L	300 μ L	1200 μ L
✗	✗	✗	✗



MICROTUBE DOMINO
PN: 186009601

Eppendorf 2 mL DNA LoBind[®] microtube



Manufacturer:
Eppendorf

Part number:
0030108078

1-channel pipettes					
10 μ L	120 μ L	300 μ L	1000 μ L	5mL	10mL
✓	✓	✓	✓	✓	600

8-channel pipettes			
10 μ L	120 μ L	300 μ L	1200 μ L
✗	✗	✗	✗



MICROTUBE DOMINO
PN: 186009601

Eppendorf 2 mL protein LoBind[®] microtube



Manufacturer:
Eppendorf

Part number:
0030108132

1-channel pipettes					
10 μ L	120 μ L	300 μ L	1000 μ L	5mL	10mL
✓	✓	✓	✓	✓	600

8-channel pipettes			
10 μ L	120 μ L	300 μ L	1200 μ L
✗	✗	✗	✗



MICROTUBE DOMINO
PN: 186009601

Eppendorf 2 mL Safe-Lock tube



Manufacturer:
Eppendorf

Part number:
0030120094

1-channel pipettes					
10 μ L	120 μ L	300 μ L	1000 μ L	5mL	10mL
✓	✓	✓	✓	✓	600

8-channel pipettes			
10 μ L	120 μ L	300 μ L	1200 μ L
✗	✗	✗	✗



MICROTUBE DOMINO
PN: 186009601

Fisherbrand™ 0.5 mL free-standing microtube



Manufacturer:
Fisher Scientific

Part number:
02-682-559

1-channel pipettes					
10µL	120µL	300µL	1000µL	5mL	10mL
✓	✓	✓	✓	200	200

8-channel pipettes			
10µL	120µL	300µL	1200µL
✗	✗	✗	✗



MICROTUBE DOMINO
PN: 186009601

Fisherbrand™ 2 mL skirted conical microtube



Manufacturer:
Fisher Scientific

Part number:
12330433

1-channel pipettes					
10µL	120µL	300µL	1000µL	5mL	10mL
✓	✓	✓	✓	1 000	1 000

8-channel pipettes			
10µL	120µL	300µL	1200µL
✗	✗	✗	✗



MICROTUBE DOMINO
PN: 186009601

Fisherbrand™ Premium 1.5 mL microtube



Manufacturer:
Fisher Scientific

Part number:
11926955

1-channel pipettes					
10µL	120µL	300µL	1000µL	5mL	10mL
✓	✓	✓	✓	✓	⚠

8-channel pipettes			
10µL	120µL	300µL	1200µL
✗	✗	✗	✗



MICROTUBE DOMINO
PN: 186009601

Sarstedt, 0.5 mL skirted microtube with knurls



Manufacturer:
Sarstedt

Part number:
72.730.711

1-channel pipettes					
10 μ L	120 μ L	300 μ L	1000 μ L	5mL	10mL
✓	✓	✓	✓	✓	✓

8-channel pipettes			
10 μ L	120 μ L	300 μ L	1200 μ L
✗	✗	✗	✗



MICROTUBE DOMINO
PN: 186009601

Sarstedt, 1.5 mL conical microtube



Manufacturer:
Sarstedt

Part number:
72.690.001

1-channel pipettes					
10 μ L	120 μ L	300 μ L	1000 μ L	5mL	10mL
✓	✓	✓	✓	✓	⚠

8-channel pipettes			
10 μ L	120 μ L	300 μ L	1200 μ L
✗	✗	✗	✗



MICROTUBE DOMINO
PN: 186009601

Sarstedt, 2 mL screw-cap microtube



Manufacturer:
Sarstedt

Part number:
72.664

1-channel pipettes					
10 μ L	120 μ L	300 μ L	1000 μ L	5mL	10mL
✓	✓	✓	✓	1 000	1 000

8-channel pipettes			
10 μ L	120 μ L	300 μ L	1200 μ L
✗	✗	✗	✗



MICROTUBE DOMINO
PN: 186009601

Sarstedt 2 mL Polypropylene Reaction Tube



Manufacturer:
Sarstedt

Part number:
72.691

1-channel pipettes					
10 μ L	120 μ L	300 μ L	1000 μ L	5mL	10mL
✓	✓	✓	✓	✓	300

8-channel pipettes			
10 μ L	120 μ L	300 μ L	1200 μ L
✗	✗	✗	✗



MICROTUBE DOMINO
PN: 186009601

STARLAB, TubeOne[®] 2 mL microtube



Manufacturer:
STARLAB

Part number:
S1620-2700

1-channel pipettes					
10 μ L	120 μ L	300 μ L	1000 μ L	5mL	10mL
✓	✓	✓	✓	✓	500

8-channel pipettes			
10 μ L	120 μ L	300 μ L	1200 μ L
✗	✗	✗	✗



MICROTUBE DOMINO
PN: 186009601

Ordering product number

186010202

OneLab reference: [218.4031]

5ML MICROTUBE DOMINO



The 5mL Microtube Domino is designed to hold a growing variety of mid-volume microtubes in various formats. It features a design that maintains attached caps of certain tubes in a vertical position to avoid automation collisions. It can hold up to 15 tubes.

**SEE THIS DOMINO
ON OUR E-SHOP**

Eppendorf 5 mL DNA LoBind[®] microtube

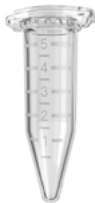

Manufacturer:
Eppendorf

Part number:
0030108310

1-channel pipettes					
10 μ L	120 μ L	300 μ L	1000 μ L	5mL	10mL
✓	✓	✓	✓	✓	✓

8-channel pipettes			
10 μ L	120 μ L	300 μ L	1200 μ L
✗	✗	✗	✗



5ML MICROTUBE
DOMINO
PN: 186010202

Eppendorf 5 mL protein LoBind[®] microtube



Manufacturer:
Eppendorf

Part number:
0030108302

1-channel pipettes					
10 μ L	120 μ L	300 μ L	1000 μ L	5mL	10mL
✓	✓	✓	✓	✓	✓

8-channel pipettes			
10 μ L	120 μ L	300 μ L	1200 μ L
✗	✗	✗	✗



5ML MICROTUBE
DOMINO
PN: 186010202

Eppendorf 5 mL Tube® with screw cap



Manufacturer:
Eppendorf

Part number:
0030122305

1-channel pipettes					
10µL	120µL	300µL	1000µL	5mL	10mL
✓	✓	✓	✓	✓	✓

8-channel pipettes			
10µL	120µL	300µL	1200µL
✗	✗	✗	✗



5ML MICROTUBE
DOMINO
PN: 186010202

Eppendorf 5 mL Tube[®] with snap cap

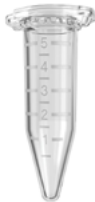

Manufacturer:
Eppendorf

Part number:
0030119401

1-channel pipettes					
10 μ L	120 μ L	300 μ L	1000 μ L	5mL	10mL
✓	✓	✓	✓	✓	✓

8-channel pipettes			
10 μ L	120 μ L	300 μ L	1200 μ L
✗	✗	✗	✗



5ML MICROTUBE
DOMINO
PN: 186010202

VWR® 5 mL snap-cap centrifuge tube



Manufacturer:
VWR International

Part number:
10002-728

1-channel pipettes					
10µL	120µL	300µL	1000µL	5mL	10mL
✓	✓	✓	✓	✓	✓

8-channel pipettes			
10µL	120µL	300µL	1200µL
✗	✗	✗	✗



5ML MICROTUBE
DOMINO
PN: 186010202

Ordering product number

186010089

OneLab reference: [218.2242]

5ML ROUND BOTTOM TUBE DOMINO



The 5mL Round Bottom Tube Domino is designed to hold round-bottom tubes with working volumes of up to 5mL. It can hold up to 24 tubes.

**SEE THIS DOMINO
ON OUR E-SHOP**

Falcon® 5 mL round bottom test tube



Manufacturer:
Corning Inc.

Part number:
352008

1-channel pipettes					
10µL	120µL	300µL	1000µL	5mL	10mL
✓	✓	✓	1 000	2 000	🧪

8-channel pipettes			
10µL	120µL	300µL	1200µL
✗	✗	✗	✗



5ML ROUND BOTTOM
TUBE DOMINO
PN: 186010089

Fisherbrand™ 6 mL round-bottom glass tube with plain end



Manufacturer:
Fisher Scientific

Part number:
14-961-26

1-channel pipettes					
10µL	120µL	300µL	1000µL	5mL	10mL
✓	✓	✓	✓	✓	⚠

8-channel pipettes			
10µL	120µL	300µL	1200µL
✗	✗	✗	✗



5ML ROUND BOTTOM
TUBE DOMINO
PN: 186010089

Fisherbrand™ 6 mL round-bottom glass tube with plain end



Manufacturer:
Fisher Scientific

Part number:
14-961-26

1-channel pipettes					
10µL	120µL	300µL	1000µL	5mL	10mL
✓	✓	✓	✓	✓	⚠

8-channel pipettes			
10µL	120µL	300µL	1200µL
✗	✗	✗	✗



5ML ROUND BOTTOM
TUBE DOMINO
PN: 186010089

Sarstedt, 3.5 mL skirted V-bottom screw-cap tube



Manufacturer:
Sarstedt

Part number:
60.549.001

1-channel pipettes					
10 μ L	120 μ L	300 μ L	1000 μ L	5mL	10mL
✓	✓	✓	✓	2 000	2 500

8-channel pipettes			
10 μ L	120 μ L	300 μ L	1200 μ L
✗	✗	✗	✗



5ML ROUND BOTTOM
TUBE DOMINO
PN: 186010089

VACUETTE® 2 mL virus stabilization tube



Manufacturer:
Greiner Bio-One

Part number:
456162

1-channel pipettes					
10µL	120µL	300µL	1000µL	5mL	10mL
700	✓	✓	✓	✓	5 000

8-channel pipettes			
10µL	120µL	300µL	1200µL
✗	✗	✗	✗



**5ML ROUND BOTTOM
TUBE DOMINO**
PN: 186010089

Ordering product number

186010575

OneLab reference: [218.5341]

5ML CRYOTUBE DOMINO



The 5mL Cryotube Domino is specifically designed to hold a growing array of cryotubes. It can hold up to 24 tubes.

**SEE THIS DOMINO
ON OUR E-SHOP**

5 mL Cryotubes with External Thread



Manufacturer:
Cromakit

Part number:
BGN002

1-channel pipettes					
10 μ L	120 μ L	300 μ L	1000 μ L	5mL	10mL
✓	✓	✓	✓	✓	✓

8-channel pipettes			
10 μ L	120 μ L	300 μ L	1200 μ L
✗	✗	✗	✗



5ML CRYOTUBE DOMINO
PN: 186010575

Ordering product number

186010281

OneLab reference: [218.4281]

LABELED TEST TUBE DOMINO



The Labeled Test Tube Domino is specifically designed to hold a growing array of sample collection tubes. It's design leaves a small buffer zone around the tubes to avoid damaging their indispensable labels while not compromising on automation precision.

**SEE THIS DOMINO
ON OUR E-SHOP**

BD Vacutainer® 4 mL EDTA blood collection tube



LABELED TEST
TUBE DOMINO
PN: 186010281



Manufacturer:
Becton Dickinson

Part number:
367861

1-channel pipettes

10µL	120µL	300µL	1000µL	5mL	10mL
✓	✓	✓	✓	✓	3 000

8-channel pipettes

10µL	120µL	300µL	1200µL
✗	✗	✗	✗

VACUETTE® 3 mL K2EDTA collection tube



Manufacturer:
Greiner Bio-One

Part number:
454246

1-channel pipettes					
10µL	120µL	300µL	1000µL	5mL	10mL
500	✓	✓	✓	✓	3 500

8-channel pipettes			
10µL	120µL	300µL	1200µL
✗	✗	✗	✗



**LABELED TEST
TUBE DOMINO**
PN: 186010281

VACUETTE® 6 mL Trace Elements Sodium Heparin tube



Manufacturer:
Greiner Bio-One

Part number:
456275

1-channel pipettes					
10µL	120µL	300µL	1000µL	5mL	10mL
600	✓	✓	✓	✓	5 000

8-channel pipettes			
10µL	120µL	300µL	1200µL
✗	✗	✗	✗



LABELED TEST
TUBE DOMINO
PN: 186010281

VACUETTE® 4 mL Z No Additive collection tube



Manufacturer:
Greiner Bio-One

Part number:
454001

1-channel pipettes					
10µL	120µL	300µL	1000µL	5mL	10mL
✓	✓	✓	✓	✓	3 500

8-channel pipettes			
10µL	120µL	300µL	1200µL
✗	✗	✗	✗



LABELED TEST
TUBE DOMINO
PN: 186010281

Ordering product number

186010576

OneLab reference: [218.5311]

CONICAL BOTTOM TUBE DOMINO



The Conical Bottom Tube Domino is specifically designed to hold a growing variety of large-volume and non self-standing tubes that have a conical bottom. It can hold up to 2 tubes.

**SEE THIS DOMINO
ON OUR E-SHOP**

Corning® 250 mL centrifuge tube w/ plug seal cap



Manufacturer:
Corning Inc.

Part number:
430776

1-channel pipettes					
10µL	120µL	300µL	1000µL	5mL	10mL
70 000	12 000	10 000	✓	✓	✓

8-channel pipettes			
10µL	120µL	300µL	1200µL
✗	✗	✗	✗



CONICAL BOTTOM
TUBE DOMINO
PN: 186010576

Ordering product number

186010163

OneLab reference: [218.2931]

2ML CRYOGENIC STORAGE VIAL DOMINO



The 2mL Cryogenic Storage Vial Domino is designed to hold the most commonly used, 2mL cryogenic vials. It can hold up to 24 vials in individual positions.

**SEE THIS DOMINO
ON OUR E-SHOP**

Fisherbrand™ Cryogenic 2 mL external thread vial



Manufacturer:
Fisher Scientific

Part number:
10-500-26

1-channel pipettes					
10µL	120µL	300µL	1000µL	5mL	10mL
✓	✓	✓	✓	✓	500

8-channel pipettes			
10µL	120µL	300µL	1200µL
✗	✗	✗	✗



**2ML CRYOGENIC
STORAGE VIAL DOMINO**
PN: 186010163

Ordering product number

186010173

OneLab reference: [218.3391]

13ML TUBE DOMINO



The 13mL Tube Domino is designed to hold a growing array of tubes with the specific volume capacity of 13mL but in various formats. It can hold up to 24 Tubes.

**SEE THIS DOMINO
ON OUR E-SHOP**

16x100mm collection tube, COPAN UTM[®] medium



Manufacturer:
COPAN Diagnostics,
Inc

Part number:
330C

1-channel pipettes					
10 μ L	120 μ L	300 μ L	1000 μ L	5mL	10mL
✓	✓	✓	✓	✓	✓

8-channel pipettes			
10 μ L	120 μ L	300 μ L	1200 μ L
✗	✗	✗	✗



13ML TUBE DOMINO
PN: 186010173

DigiTUBE 15 mL 17x100mm autosampler tube



Manufacturer:
SCP SCIENCE

Part number:
010-515-607

1-channel pipettes					
10 μ L	120 μ L	300 μ L	1000 μ L	5mL	10mL
300	✓	✓	✓	✓	✓

8-channel pipettes			
10 μ L	120 μ L	300 μ L	1200 μ L
✗	✗	✗	✗



13ML TUBE DOMINO
PN: 186010173

Sarstedt, 13 mL U-bottom screw-cap tube



Manufacturer:
Sarstedt

Part number:
60.540.052

1-channel pipettes					
10 μ L	120 μ L	300 μ L	1000 μ L	5mL	10mL
1 300	✓	✓	✓	✓	✓

8-channel pipettes			
10 μ L	120 μ L	300 μ L	1200 μ L
✗	✗	✗	✗



13ML TUBE DOMINO
PN: 186010173

Ordering product number

186010165

OneLab reference: [218.3031]

14ML ROUND BOTTOM TEST TUBE DOMINO



The 14mL Round Bottom Test Tube Domino is designed to hold specific tubes bearing the same name. It can hold up to 24 tubes.

[SEE THIS DOMINO
ON OUR E-SHOP](#)

DURAN® Disposable Culture Tubes with Screw Cap



Manufacturer:
DWK Life Sciences

Part number:
391-0145

1-channel pipettes					
10µL	120µL	300µL	1000µL	5mL	10mL
2 500	✓	✓	✓	✓	6 000

8-channel pipettes			
10µL	120µL	300µL	1200µL
✗	✗	✗	✗



**14ML ROUND BOTTOM
TEST TUBE DOMINO**
PN: 186010165

Falcon® 14 mL round bottom test tube



Manufacturer:
Corning Inc.

Part number:
352059

1-channel pipettes

10 μ L	120 μ L	300 μ L	1000 μ L	5mL	10mL
✓	✓	✓	✓	✓	✓

8-channel pipettes

10 μ L	120 μ L	300 μ L	1200 μ L
✗	✗	✗	✗



14ML ROUND BOTTOM
TEST TUBE DOMINO
PN: 186010165

Ordering product number

186010087

OneLab reference: [218.2062]

15ML CONICAL CENTRIFUGE TUBE DOMINO



The 15mL Conical Centrifuge Tube Domino is designed to hold a growing array of standard, non self-standing 15mL tubes. It can hold up to 24 tubes.

[SEE THIS DOMINO
ON OUR E-SHOP](#)

15 ml Centrifuge Tube, Conical, Loose (Sterile)



Manufacturer:
Starlab

Part number:
E1415-0100

1-channel pipettes					
10 μ L	120 μ L	300 μ L	1000 μ L	5mL	10mL
3 500	1 000	1 000	✓	✓	✓

8-channel pipettes			
10 μ L	120 μ L	300 μ L	1200 μ L
✗	✗	✗	✗



15ML CONICAL
CENTRIFUGE
TUBE DOMINO
PN: 186010087

CELLSTAR® 15 mL conical screw-cap tube



Manufacturer:
Greiner Bio-One

Part number:
188261

1-channel pipettes					
10µL	120µL	300µL	1000µL	5mL	10mL
4 000	1 000	1 000	✓	✓	1 500

8-channel pipettes			
10µL	120µL	300µL	1200µL
✗	✗	✗	✗



15ML CONICAL
CENTRIFUGE
TUBE DOMINO
PN: 186010087

CELLSTAR® 15 mL conical screw-cap tube, bulk



Manufacturer:
Greiner Bio-One

Part number:
188271

1-channel pipettes					
10µL	120µL	300µL	1000µL	5mL	10mL
4 000	1 000	1 000	✓	✓	1 500

8-channel pipettes			
10µL	120µL	300µL	1200µL
✗	✗	✗	✗



15ML CONICAL
CENTRIFUGE
TUBE DOMINO
PN: 186010087

Conical 15mL PP Tube centrifuge tube



Manufacturer:
VWR International

Part number:
525-0604

1-channel pipettes					
10 μ L	120 μ L	300 μ L	1000 μ L	5mL	10mL
3 500	✓	✓	✓	✓	✓

8-channel pipettes			
10 μ L	120 μ L	300 μ L	1200 μ L
✗	✗	✗	✗



15ML CONICAL
CENTRIFUGE
TUBE DOMINO
PN: 186010087

Corning® 15 mL conical centrifuge tube



Manufacturer:
Corning Inc.

Part number:
430790

1-channel pipettes					
10µL	120µL	300µL	1000µL	5mL	10mL
4 000	1 000	1 000	✓	✓	1 500

8-channel pipettes			
10µL	120µL	300µL	1200µL
✗	✗	✗	✗



15ML CONICAL
CENTRIFUGE
TUBE DOMINO
PN: 186010087

Falcon® 15 mL conical centrifuge tube



Manufacturer:
Corning Inc.

Part number:
352096

1-channel pipettes					
10µL	120µL	300µL	1000µL	5mL	10mL
4 000	1 000	1 000	✓	✓	1 500

8-channel pipettes			
10µL	120µL	300µL	1200µL
✗	✗	✗	✗



15ML CONICAL
CENTRIFUGE
TUBE DOMINO
PN: 186010087

Ordering product number

186010190

OneLab reference: [218.3601]

20ML C15 B GLASS VIAL DOMINO



This Domino is designed to hold bespoke 20 mL C15 B Glass Vials. It can hold up to 15 vials.

**SEE THIS DOMINO
ON OUR E-SHOP**

20 mL C15 B glass vial



Manufacturer:
OEM

Part number:
N/A

1-channel pipettes					
10 μ L	120 μ L	300 μ L	1000 μ L	5mL	10mL
✓	✓	✓	✓	✓	7 000

8-channel pipettes			
10 μ L	120 μ L	300 μ L	1200 μ L
✗	✗	✗	✗



20ML C15 B
GLASS VIAL DOMINO
PN: 186010190

Ordering product number

186010191

OneLab reference: [218.3631]

FLAVER 30ML GLASS VIAL DOMINO



The FLAVER 30mL Glass Vial Domino is designed to hold vials bearing the same name. It can hold up to 6 vials.

[SEE THIS DOMINO
ON OUR E-SHOP](#)

FLAVER, 30 mL glass vial



Manufacturer:
FLAVER AG

Part number:
32.0030.W

1-channel pipettes					
10 μ L	120 μ L	300 μ L	1000 μ L	5mL	10mL
✓	✓	✓	✓	✓	✓

8-channel pipettes			
10 μ L	120 μ L	300 μ L	1200 μ L
✗	✗	✗	✗



FLAVER 30ML
GLASS VIAL DOMINO
PN: 186010191

Nalgene™ 30 mL narrow-mouth HDPE bottle



Manufacturer:
Nalgene

Part number:
2002-0001

1-channel pipettes					
10µL	120µL	300µL	1000µL	5mL	10mL
✓	✓	✓	✓	✓	✓

8-channel pipettes			
10µL	120µL	300µL	1200µL
✗	✗	✗	✗



FLAVER 30ML
GLASS VIAL DOMINO
PN: 186010191

Ordering product number

186010192

OneLab reference: [218.3661]

FLAVER 60ML GLASS VIAL DOMINO



The FLAVER 60mL Glass Vial Domino is designed to hold vials bearing the same name. It can hold up to 6 vials.

**SEE THIS DOMINO
ON OUR E-SHOP**

FLAVER, 60 mL glass vial



Manufacturer:
FLAVER AG

Part number:
32.0060.W

1-channel pipettes					
10 μ L	120 μ L	300 μ L	1000 μ L	5mL	10mL
✓	✓	✓	✓	✓	✓

8-channel pipettes			
10 μ L	120 μ L	300 μ L	1200 μ L
✗	✗	✗	✗



FLAVER 60ML
GLASS VIAL DOMINO
PN: 186010192

Ordering product number

186009614

OneLab reference: [218.2032]

50ML CONICAL CENTRIFUGE TUBE DOMINO



The 50mL Conical Centrifuge Tube Domino is designed to hold a growing array of standard, non self-standing 50mL tubes. It can hold up to 8 tubes.

**SEE THIS DOMINO
ON OUR E-SHOP**

25mL Eppendorf Conical Tubes



Manufacturer:
Eppendorf

Part number:
0030122437

1-channel pipettes					
10µL	120µL	300µL	1000µL	5mL	10mL
✓	✓	✓	✓	✓	✓

8-channel pipettes			
10µL	120µL	300µL	1200µL
✗	✗	✗	✗



**50mL CONICAL
CENTRIFUGE
TUBE DOMINO**
PN: 186009614

50mL ROTILABO® Sterile Centrifuge Tube



Manufacturer:
Roth

Part number:
N463.1

1-channel pipettes					
10µL	120µL	300µL	1000µL	5mL	10mL
✓	✓	✓	✓	✓	✓

8-channel pipettes			
10µL	120µL	300µL	1200µL
✗	✗	✗	✗



50ML CONICAL
CENTRIFUGE
TUBE DOMINO
PN: 186009614

CELLSTAR® 50 mL conical screw-cap tube



Manufacturer:
Greiner Bio-One

Part number:
227261

1-channel pipettes					
10µL	120µL	300µL	1000µL	5mL	10mL
✓	✓	✓	✓	✓	✓

8-channel pipettes			
10µL	120µL	300µL	1200µL
✗	✗	✗	✗



50ML CONICAL
CENTRIFUGE
TUBE DOMINO
PN: 186009614

Corning® 50 mL conical centrifuge tube



Manufacturer:
Corning Inc.

Part number:
430290

1-channel pipettes					
10µL	120µL	300µL	1000µL	5mL	10mL
✓	✓	✓	✓	✓	✓

8-channel pipettes			
10µL	120µL	300µL	1200µL
✗	✗	✗	✗



50ML CONICAL
CENTRIFUGE
TUBE DOMINO
PN: 186009614

Falcon® 50 mL conical centrifuge tube



Manufacturer:
Corning Inc.

Part number:
352070

1-channel pipettes					
10µL	120µL	300µL	1000µL	5mL	10mL
✓	✓	✓	✓	✓	✓

8-channel pipettes			
10µL	120µL	300µL	1200µL
✗	✗	✗	✗



50ML CONICAL
CENTRIFUGE
TUBE DOMINO
PN: 186009614

Greiner, 50 mL conical bottom tube



Manufacturer:
Greiner Bio-One

Part number:
227201

1-channel pipettes					
10 μ L	120 μ L	300 μ L	1000 μ L	5mL	10mL
✓	✓	✓	✓	✓	✓

8-channel pipettes			
10 μ L	120 μ L	300 μ L	1200 μ L
✗	✗	✗	✗



50ML CONICAL
CENTRIFUGE
TUBE DOMINO
PN: 186009614

Nunc™ 50 mL conical centrifuge tube



Manufacturer:
Thermo Scientific

Part number:
339652

1-channel pipettes					
10µL	120µL	300µL	1000µL	5mL	10mL
✓	✓	✓	✓	✓	✓

8-channel pipettes			
10µL	120µL	300µL	1200µL
✗	✗	✗	✗



50ML CONICAL
CENTRIFUGE
TUBE DOMINO
PN: 186009614

Sarstedt 50 mL Conical Screw Cap Tube



Manufacturer:
Sarstedt

Part number:
62547254

1-channel pipettes					
10 μ L	120 μ L	300 μ L	1000 μ L	5mL	10mL
✓	✓	✓	✓	✓	✓

8-channel pipettes			
10 μ L	120 μ L	300 μ L	1200 μ L
✗	✗	✗	✗



50ML CONICAL
CENTRIFUGE
TUBE DOMINO
PN: 186009614

VWR® 50 mL conical centrifuge tube



Manufacturer:
VWR International

Part number:
525-0610

1-channel pipettes					
10µL	120µL	300µL	1000µL	5mL	10mL
✓	✓	✓	✓	✓	✓

8-channel pipettes			
10µL	120µL	300µL	1200µL
✗	✗	✗	✗



50ML CONICAL
CENTRIFUGE
TUBE DOMINO
PN: 186009614

Ordering product number

186010582

OneLab reference: [218.5671]

50ML PREPTUBE DOMINO



The 50mL PrepTube Domino is specifically designed for tubes bearing the same name used with Distek's PrepEngine system. It can hold up to 3 tubes.

**SEE THIS DOMINO
ON OUR E-SHOP**

50mL PrepTube for Sample Preparation, for Distek PrepEngine



Manufacturer:
VWR International

Part number:
N/A

1-channel pipettes					
10 μ L	120 μ L	300 μ L	1000 μ L	5mL	10mL
✓	✓	✓	✓	✓	✓

8-channel pipettes			
10 μ L	120 μ L	300 μ L	1200 μ L
✗	✗	✗	✗



50mL PREPTUBE
DOMINO
PN: 186010582

Ordering product number

186010092

OneLab reference: [218.3091]

4ML AUTOSAMPLER VIAL DOMINO



The 4mL Autosampler Vial Domino is designed to hold a growing array of vials. It can hold up to 24 vials.

**SEE THIS DOMINO
ON OUR E-SHOP**

Fisherbrand™ 1.8 mL threaded amber glass vial



Manufacturer:
Fisher Scientific

Part number:
03-339-23A

1-channel pipettes					
10µL	120µL	300µL	1000µL	5mL	10mL
✓	✓	✓	✓	1 800	2 800

8-channel pipettes			
10µL	120µL	300µL	1200µL
✗	✗	✗	✗



4ML AUTOSAMPLER
VIAL DOMINO
PN: 186010092

Fisherbrand™ 4 mL screw-top autosampler vial



Manufacturer:
Fisher Scientific

Part number:
03-391-19

1-channel pipettes					
10µL	120µL	300µL	1000µL	5mL	10mL
✓	✓	✓	✓	2 000	3 500

8-channel pipettes			
10µL	120µL	300µL	1200µL
✗	✗	✗	✗



4ML AUTOSAMPLER
VIAL DOMINO
PN: 186010092

Fisherbrand™ Glass Threaded 1dr (3.7mL) vial



Manufacturer:
Fisher Scientific

Part number:
03-338A

1-channel pipettes					
10µL	120µL	300µL	1000µL	5mL	10mL
✓	✓	✓	✓	1 700	2 800

8-channel pipettes			
10µL	120µL	300µL	1200µL
✗	✗	✗	✗



4ML AUTOSAMPLER
VIAL DOMINO
PN: 186010092

Interchim, 4 mL 15x45 mm screw-top glass vial



Manufacturer:
Interchim

Part number:
181859

1-channel pipettes					
10 μ L	120 μ L	300 μ L	1000 μ L	5mL	10mL
✓	✓	✓	✓	1 500	2 750

8-channel pipettes			
10 μ L	120 μ L	300 μ L	1200 μ L
✗	✗	✗	✗



4ML AUTOSAMPLER
VIAL DOMINO
PN: 186010092

Ordering product number

186010168

OneLab reference: [218.3161]

SCIEX UNIVERSAL VIAL DOMINO



The SCIEX Universal Vial Domino is designed to hold specific one-time use vials. It can hold up to 24 vials.

**SEE THIS DOMINO
ON OUR E-SHOP**

SCIEX Universal Vial



Manufacturer:
SCIEX

Part number:
A62251

1-channel pipettes					
10 μ L	120 μ L	300 μ L	1000 μ L	5mL	10mL
✓	✓	✓	300	300	600

8-channel pipettes			
10 μ L	120 μ L	300 μ L	1200 μ L
✗	✗	✗	✗



SCIEX UNIVERSAL
VIAL DOMINO
PN: 186010168

Ordering product number

186010283

OneLab reference: [218.4311]

SCIEX 6X6 TRAY DOMINO

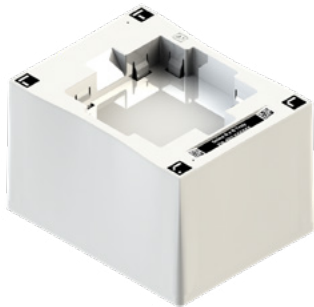

The SCIEX 6x6 Tray Domino is specifically designed to hold a dedicated 6x6 tray for Universal Vials.

**SEE THIS DOMINO
ON OUR E-SHOP**

SCIEX Universal Vial in 6x6 tray



Manufacturer:
SCIEX

Part number:
A62251

1-channel pipettes					
10 μ L	120 μ L	300 μ L	1000 μ L	5mL	10mL
✓	✓	✓	500	200	700

8-channel pipettes			
10 μ L	120 μ L	300 μ L	1200 μ L
✗	✗	✗	✗



SCIEX 6X6
TRAY DOMINO
PN: 186010283

Ordering product number

186010198

OneLab reference: [218.3941]

5ML SERUM VIAL DOMINO



The 5mL Serum Vial Domino is specifically designed to hold Serum vials with the specific volume capacity of up to 5mL. It can hold up to 15 vials.

**SEE THIS DOMINO
ON OUR E-SHOP**

WHEATON® 5 mL clear glass serum vial



Manufacturer:
DWK Life Sciences

Part number:
223685

1-channel pipettes					
10µL	120µL	300µL	1000µL	5mL	10mL
✓	✓	✓	✓	✓	✓

8-channel pipettes			
10µL	120µL	300µL	1200µL
✗	✗	✗	✗



5ML SERUM
VIAL DOMINO
PN: 186010198

Ordering product number

186010164

OneLab reference: [218.2961]

8ML SAMPLE VIAL DOMINO



The 8mL Sample Vial Domino is designed to hold vials with the specific volume capacity of 8mL. It can hold up to 24 vials.

**SEE THIS DOMINO
ON OUR E-SHOP**

Fisherbrand™ 8 mL Clear Screw Neck Vial



Manufacturer:
Fisher Scientific

Part number:
15091703

1-channel pipettes					
10µL	120µL	300µL	1000µL	5mL	10mL
✓	✓	✓	✓	3 500	5 000

8-channel pipettes			
10µL	120µL	300µL	1200µL
✗	✗	✗	✗



8ML SAMPLE
VIAL DOMINO
PN: 186010164

SAR 16x93mm clear glass test tube



Manufacturer:

OEM

Part number:

N/A

1-channel pipettes

10 μ L	120 μ L	300 μ L	1000 μ L	5mL	10mL
✓	✓	✓	✓	✓	✓

8-channel pipettes

10 μ L	120 μ L	300 μ L	1200 μ L
✗	✗	✗	✗



8ML SAMPLE
VIAL DOMINO
PN: 186010164

WHEATON® LAB FILE® 8 mL standard clear sample vial



Manufacturer:
DWK Life Sciences

Part number:
224804

1-channel pipettes					
10µL	120µL	300µL	1000µL	5mL	10mL
✓	✓	✓	✓	4 000	5 500

8-channel pipettes			
10µL	120µL	300µL	1200µL
✗	✗	✗	✗



8ML SAMPLE
VIAL DOMINO
PN: 186010164

Ordering product number

186010199

OneLab reference: [218.3911]

10ML SERUM VIAL DOMINO



The 10mL Serum Vial Domino is specifically designed to hold Serum vials with the specific volume capacity of up to 10mL. It can hold up to 15 vials.

**SEE THIS DOMINO
ON OUR E-SHOP**

WHEATON® 10 mL clear glass serum vial



Manufacturer:
DWK Life Sciences

Part number:
223686

1-channel pipettes					
10µL	120µL	300µL	1000µL	5mL	10mL
✓	✓	✓	✓	✓	✓

8-channel pipettes			
10µL	120µL	300µL	1200µL
✗	✗	✗	✗



**10ML SERUM
VIAL DOMINO**
PN: 186010199

Ordering product number

186010201

OneLab reference: [218.3881]

20ML SERUM VIAL DOMINO



The 20mL Serum Vial Domino is specifically designed to hold Serum vials with the specific volume capacity of up to 20mL. It can hold up to 8 vials.

**SEE THIS DOMINO
ON OUR E-SHOP**

WHEATON® 20 mL clear glass serum vial



Manufacturer:
DWK Life Sciences

Part number:
223687

1-channel pipettes					
10µL	120µL	300µL	1000µL	5mL	10mL
✓	✓	✓	✓	✓	✓

8-channel pipettes			
10µL	120µL	300µL	1200µL
✗	✗	✗	✗



20ML SERUM
VIAL DOMINO
PN: 186010201

Ordering product number

186010097

OneLab reference: [218.2361]

20ML REACTION VIAL DOMINO



The 20mL Reaction Vial Domino is designed to hold a growing array of mid-range volume vials. It can hold up to 12 vials.

**SEE THIS DOMINO
ON OUR E-SHOP**

Chemglass, 20 mL screw-top reaction vial



Manufacturer:
Chemglass

Part number:
CG-4912-05

1-channel pipettes					
10 μ L	120 μ L	300 μ L	1000 μ L	5mL	10mL
✓	✓	✓	✓	✓	✓

8-channel pipettes			
10 μ L	120 μ L	300 μ L	1200 μ L
✗	✗	✗	✗



20ML REACTION VIAL
DOMINO
PN: 186010097

Fisherbrand™ 20mL Borosilicate Glass Scintillation Vial



Manufacturer:
Fisher Scientific

Part number:
03-337-5

1-channel pipettes					
10µL	120µL	300µL	1000µL	5mL	10mL
✓	✓	✓	✓	✓	✓

8-channel pipettes			
10µL	120µL	300µL	1200µL
✗	✗	✗	✗



20ML REACTION VIAL
DOMINO
PN: 186010097

Fisherbrand™ Glass Threaded 6dr (22.2mL) vial



Manufacturer:
Fisher Scientific

Part number:
03-338G

1-channel pipettes					
10 μ L	120 μ L	300 μ L	1000 μ L	5mL	10mL
✓	✓	✓	✓	✓	✓

8-channel pipettes			
10 μ L	120 μ L	300 μ L	1200 μ L
✗	✗	✗	✗



20ML REACTION VIAL
DOMINO
PN: 186010097

VWR® 20 mL EPA screw neck vial



Manufacturer:
VWR International

Part number:
VWRI548-0154A

1-channel pipettes					
10µL	120µL	300µL	1000µL	5mL	10mL
✓	✓	✓	✓	✓	✓

8-channel pipettes			
10µL	120µL	300µL	1200µL
✗	✗	✗	✗



20ML REACTION VIAL
DOMINO
PN: 186010097

Ordering product number

186010166

OneLab reference: [218.3061]

22ML GLASS VIAL DOMINO



The 22mL Glass Vial Domino is designed to hold specific glass vials with a total working volume of 22mL. It can hold up to 15 vials.

**SEE THIS DOMINO
ON OUR E-SHOP**

Supelco, 22 mL screw-top amber glass vial w/ Thermoset cap



Manufacturer:
Merck

Part number:
27004

1-channel pipettes

10 μ L	120 μ L	300 μ L	1000 μ L	5mL	10mL
✓	✓	✓	✓	✓	✓

8-channel pipettes

10 μ L	120 μ L	300 μ L	1200 μ L
✗	✗	✗	✗



22ML GLASS VIAL
DOMINO
PN: 186010166

Thermo Scientific™ 22 mL screw-top sample vial



Manufacturer:
Thermo Scientific

Part number:
B7990-5

1-channel pipettes					
10µL	120µL	300µL	1000µL	5mL	10mL
✓	✓	✓	✓	✓	✓

8-channel pipettes			
10µL	120µL	300µL	1200µL
✗	✗	✗	✗



22ML GLASS VIAL
DOMINO
PN: 186010166

Ordering product number

186010194

OneLab reference: [218.3731]

29ML GLASS CULTURE TUBE DOMINO



The 29mL Glass Culture Tube Domino is designed to hold tall tubes with the specific volume capacity of up to 29mL. It can hold up to 24 tubes.

**SEE THIS DOMINO
ON OUR E-SHOP**

Globe Scientific, 29 mL 18x150mm glass culture tube



Manufacturer:
Globe Scientific Inc.

Part number:
1519

1-channel pipettes					
10 μ L	120 μ L	300 μ L	1000 μ L	5mL	10mL
11 000	8 000	8 000	750	4 500	7 500

8-channel pipettes			
10 μ L	120 μ L	300 μ L	1200 μ L
✗	✗	✗	✗



**29ML GLASS CULTURE
TUBE DOMINO**
PN: 186010194

Ordering product number

186010307

OneLab reference: [218.4871]

Ø9MM GLASS VIAL DOMINO



The Ø9mm Glass Vial Domino is specifically designed to hold a growing array of glass vials with an exterior diameter of ~9mm. It can hold up to 48 vials.

**SEE THIS DOMINO
ON OUR E-SHOP**

Fisherbrand™ 1 mL short-style glass shell vial



Manufacturer:
Fisher Scientific

Part number:
03-339-30A

1-channel pipettes					
10µL	120µL	300µL	1000µL	5mL	10mL
✓	✓	✓	600	600	🧪

8-channel pipettes			
10µL	120µL	300µL	1200µL
✗	✗	✗	✗



Ø9MM GLASS
VIAL DOMINO
PN: 186010307

KIMBLE® 1 mL clear glass shell vial



Ø9MM GLASS
VIAL DOMINO
PN: 186010307



Manufacturer:
DWK Life Sciences

Part number:
60831D-843

1-channel pipettes

10µL	120µL	300µL	1000µL	5mL	10mL
✓	✓	✓	900	🧪	🧪

8-channel pipettes

10µL	120µL	300µL	1200µL
✗	✗	✗	✗

Ordering product number

186010280

OneLab reference: [218.4221]

Ø12MM VIAL DOMINO



The Ø12mm Vial Domino is specifically designed to hold a growing array of tubes with an exterior diameter of ~12mm. It can hold up to 24 vials.

**SEE THIS DOMINO
ON OUR E-SHOP**

Waters 300 μ L 12x32mm screw neck vial



SEE THIS CONSUMABLE
ON OUR E-SHOP

Manufacturer:
Waters Corporation

Part number:
186002639

1-channel pipettes

10 μ L	120 μ L	300 μ L	1000 μ L	5mL	10mL
15	✓	✓	60	100	

8-channel pipettes

10 μ L	120 μ L	300 μ L	1200 μ L
✗	✗	✗	✗



Ø12MM VIAL DOMINO
PN: 186010280

Waters 700 μ L 12x32mm screw neck vial



SEE THIS CONSUMABLE
ON OUR E-SHOP

Manufacturer:
Waters Corporation

Part number:
186005221

1-channel pipettes

10 μ L	120 μ L	300 μ L	1000 μ L	5mL	10mL
100	✓	✓	300	300	

8-channel pipettes

10 μ L	120 μ L	300 μ L	1200 μ L
✗	✗	✗	✗



Ø12MM VIAL DOMINO
PN: 186010280

Waters QuanRecovery™ 300 µL 12x32mm screw neck vial



SEE THIS CONSUMABLE
ON OUR E-SHOP

Manufacturer:
Waters Corporation

Part number:
186009186

1-channel pipettes					
10µL	120µL	300µL	1000µL	5mL	10mL
15	✓	✓	60	100	

8-channel pipettes			
10µL	120µL	300µL	1200µL
✗	✗	✗	✗



Ø12MM VIAL DOMINO
PN: 186010280

Ordering product number

186010312

OneLab reference: [218.4901]

Ø12.5MM TUBE AND VIAL DOMINO



The ø12.5mm Tube and Vial Domino is a Domino designed for versatile compatibility with both tubes and vials that have an exterior diameter of ~12.5mm. It can hold up to 48 individual labware.

**SEE THIS DOMINO
ON OUR E-SHOP**

ArcticWhite, 2 mL self-standing external thread cryovial with lip seal



Manufacturer:
ArcticWhite LLC

Part number:
CV3090102

1-channel pipettes					
10 μ L	120 μ L	300 μ L	1000 μ L	5mL	10mL
✓	✓	✓	✓	✓	1 000

8-channel pipettes			
10 μ L	120 μ L	300 μ L	1200 μ L
✗	✗	✗	✗



Ø12.5MM TUBE
AND VIAL DOMINO
PN: 186010312

ArcticWhite, 3 mL self-standing external thread cryovial with lip seal



Manufacturer:
ArcticWhite LLC

Part number:
CV3090103

1-channel pipettes					
10 μ L	120 μ L	300 μ L	1000 μ L	5mL	10mL
✓	✓	✓	✓	1 300	2 300

8-channel pipettes			
10 μ L	120 μ L	300 μ L	1200 μ L
✗	✗	✗	✗



Ø12.5MM TUBE
AND VIAL DOMINO
PN: 186010312

Ordering product number

186010257

OneLab reference: [218.3971]

Ø13MM TUBE DOMINO



The Ø13mm Tube Domino is specifically designed to hold a growing array of tubes with an exterior diameter of ~13mm. It can hold up to 24 tubes.

[SEE THIS DOMINO
ON OUR E-SHOP](#)

13x84mm collection tube, virus preservation medium



Manufacturer:
KANG JIAN Medical

Part number:
KJ502-19C

1-channel pipettes					
10 μ L	120 μ L	300 μ L	1000 μ L	5mL	10mL
✓	✓	✓	✓	✓	3 000

8-channel pipettes			
10 μ L	120 μ L	300 μ L	1200 μ L
✗	✗	✗	✗



Ø13MM TUBE DOMINO
PN: 186010257

BD Vacutainer® 2 mL EDTA blood collection tube



Manufacturer:
Becton Dickinson

Part number:
367841

1-channel pipettes					
10µL	120µL	300µL	1000µL	5mL	10mL
✓	✓	✓	✓	✓	3 500

8-channel pipettes			
10µL	120µL	300µL	1200µL
✗	✗	✗	✗



Ø13MM TUBE DOMINO
PN: 186010257

Fisherbrand™ 10 mL round-bottom glass tube with plain end



Manufacturer:
Fisher Scientific

Part number:
14-961-27

1-channel pipettes					
10µL	120µL	300µL	1000µL	5mL	10mL
500	✓	✓	✓	✓	5 500

8-channel pipettes			
10µL	120µL	300µL	1200µL
✗	✗	✗	✗



Ø13MM TUBE DOMINO
PN: 186010257

Ordering product number

186010308

OneLab reference: [218.4931]

Ø16MM VIAL DOMINO



The Ø16mm Vial Domino is specifically designed to hold a growing array of vials with an exterior diameter of ~16mm. It can hold up to 24 vials. This Domino differs from Domino 186010298 not only by its smaller total vial capacity, but also because of the bottom format/shape of the vials it holds (flat-bottom vs. the round-bottom tubes held by Domino 186010298).

[SEE THIS DOMINO
ON OUR E-SHOP](#)

SCHOTT FIOLAX® 2 mL clear glass vial



Manufacturer:
SCHOTT Pharma

Part number:
1633341

1-channel pipettes					
10µL	120µL	300µL	1000µL	5mL	10mL
✓	✓	✓	3 000	2 500	🧪

8-channel pipettes			
10µL	120µL	300µL	1200µL
✗	✗	✗	✗



Ø16MM VIAL DOMINO
PN: 186010308

Ordering product number

186010159

OneLab reference: [218.2781]

16X90MM GLASS TUBE DOMINO



The 16x90mm Glass Tube Domino is designed to hold a growing array of tall glass tubes with a 16mm diameter. It can hold up to 24 vials

**SEE THIS DOMINO
ON OUR E-SHOP**

10 mL flat-bottom screw cap test tube



Manufacturer:
Biosigma S.p.A

Part number:
BSM440

1-channel pipettes					
10 μ L	120 μ L	300 μ L	1000 μ L	5mL	10mL
✓	✓	✓	✓	✓	✓

8-channel pipettes			
10 μ L	120 μ L	300 μ L	1200 μ L
✗	✗	✗	✗



16X90MM
GLASS TUBE DOMINO
PN: 186010159

16x100mm collection tube, IMPROVIRAL™ medium



Manufacturer:
Improve Medical

Part number:
8110111

1-channel pipettes

10µL	120µL	300µL	1000µL	5mL	10mL
✓	✓	✓	✓	✓	✓

8-channel pipettes

10µL	120µL	300µL	1200µL
✗	✗	✗	✗



16X90MM
GLASS TUBE DOMINO
PN: 186010159

16x100mm collection tube, virus preservation medium



Manufacturer:
KANG JIAN Medical

Part number:
KJ502-19A

1-channel pipettes					
10 μ L	120 μ L	300 μ L	1000 μ L	5mL	10mL
✓	✓	✓	✓	✓	✓

8-channel pipettes			
10 μ L	120 μ L	300 μ L	1200 μ L
✗	✗	✗	✗



16X90MM
GLASS TUBE DOMINO
PN: 186010159

ACC, Pyrotube[®] 16x90mm depyrogenated glass tube



Manufacturer:
Associates of Cape
Cod, Inc.

Part number:
TB16C

1-channel pipettes					
10 μ L	120 μ L	300 μ L	1000 μ L	5mL	10mL
✓	✓	✓	✓	✓	✓

8-channel pipettes			
10 μ L	120 μ L	300 μ L	1200 μ L
✗	✗	✗	✗



16X90MM
GLASS TUBE DOMINO
PN: 186010159

Charles River, 16x90mm endotoxin-free glass tube



Manufacturer:
Charles River

Part number:
TL700

1-channel pipettes					
10 μ L	120 μ L	300 μ L	1000 μ L	5mL	10mL
✓	✓	✓	✓	✓	✗

8-channel pipettes			
10 μ L	120 μ L	300 μ L	1200 μ L
✗	✗	✗	✗



16X90MM
GLASS TUBE DOMINO
PN: 186010159

Radleys, GreenHouse Plus reaction tube



Manufacturer:

Radleys

Part number:

RR99612

1-channel pipettes					
10 μ L	120 μ L	300 μ L	1000 μ L	5mL	10mL
2 500	✓	✓	✓	✓	4 000

8-channel pipettes			
10 μ L	120 μ L	300 μ L	1200 μ L
✗	✗	✗	✗



16X90MM

GLASS TUBE DOMINO

PN: 186010159

Ordering product number

186010298

OneLab reference: [218.4371]

Ø16MM 30X TUBE DOMINO



The Ø16mm 30x Tube Domino is specifically designed to hold a growing array of tubes with an exterior diameter of ~16mm. It can hold up to 30 tubes. This Domino differs from Domino 186010308 not only by its larger total tube capacity, but also because of the bottom format/shape of the vials it holds (round-bottom tubes vs. the flat-bottom vials held by Domino 186010308).

**SEE THIS DOMINO
ON OUR E-SHOP**

BRAND® AR-GLAS® 13 mL 16x100mm culture tube



Manufacturer:
BRAND

Part number:
114115

1-channel pipettes					
10µL	120µL	300µL	1000µL	5mL	10mL
5 000	2 500	2 500	✓	✓	✓

8-channel pipettes			
10µL	120µL	300µL	1200µL
✗	✗	✗	✗



Ø16MM 30X
TUBE DOMINO
PN: 186010298

DURAN® 17 mL 16x130mm test tube with straight rim



Manufacturer:
DWK Life Sciences

Part number:
261311608

1-channel pipettes					
10µL	120µL	300µL	1000µL	5mL	10mL
6 000	4 000	3 500	✓	✓	10 000

8-channel pipettes			
10µL	120µL	300µL	1200µL
✗	✗	✗	✗



Ø16MM 30X
TUBE DOMINO
PN: 186010298

Globe Scientific, 14 mL 16x100mm glass culture tube



Manufacturer:
Globe Scientific Inc.

Part number:
1512

1-channel pipettes					
10 μ L	120 μ L	300 μ L	1000 μ L	5mL	10mL
5 500	2 000	2 000	✓	✓	✓

8-channel pipettes			
10 μ L	120 μ L	300 μ L	1200 μ L
✗	✗	✗	✗



Ø16MM 30X
TUBE DOMINO
PN: 186010298

Globe Scientific, 19 mL 16x125mm glass culture tube



Manufacturer:
Globe Scientific Inc.

Part number:
1515

1-channel pipettes					
10 μ L	120 μ L	300 μ L	1000 μ L	5mL	10mL
4 000	1 500	1 500	✓	✓	4 000

8-channel pipettes			
10 μ L	120 μ L	300 μ L	1200 μ L
✗	✗	✗	✗



Ø16MM 30X
TUBE DOMINO
PN: 186010298

Ordering product number

186010309

OneLab reference: [218.5131]

Ø19MM VIAL DOMINO



The Ø19mm Vial Domino is specifically designed to hold a growing array of vials with an exterior diameter of ~19mm. It can hold up to 48 vials.

[SEE THIS DOMINO
ON OUR E-SHOP](#)

CLS® 6 mL 19x40mm clear glass storage vial



Manufacturer:
Zinsser Analytic GmbH

Part number:
3088106

1-channel pipettes					
10µL	120µL	300µL	1000µL	5mL	10mL
✓	✓	✓	✓	✓	2 000

8-channel pipettes			
10µL	120µL	300µL	1200µL
✗	✗	✗	✗



Ø19MM VIAL DOMINO
PN: 186010309

WICOM 15mm Screw Vial, Brown Glass, 12mL



Manufacturer:
Wicom

Part number:
41515

1-channel pipettes					
10 μ L	120 μ L	300 μ L	1000 μ L	5mL	10mL
✓	✓	✓	✓	6 000	8 000

8-channel pipettes			
10 μ L	120 μ L	300 μ L	1200 μ L
✗	✗	✗	✗



Ø19MM VIAL DOMINO
PN: 186010309

Ordering product number

186010580

OneLab reference: [218.5461]

Ø21MM VIAL DOMINO



The ø21mm Vial Domino is specifically designed to hold vials with an exterior diameter of ~21mm. It can hold up to 15 vials.

**SEE THIS DOMINO
ON OUR E-SHOP**

Fisherbrand™ Glass Threaded 4dr (14.8mL) vial



Manufacturer:
Fisher Scientific

Part number:
03-338F

1-channel pipettes					
10µL	120µL	300µL	1000µL	5mL	10mL
✓	✓	✓	✓	✓	4 000

8-channel pipettes			
10µL	120µL	300µL	1200µL
✗	✗	✗	✗



Ø21MM VIAL DOMINO
PN: 186010580

Ordering product number

186010578

OneLab reference: [218.5431]

Ø23MM HEADSPACE VIAL DOMINO



The ø23mm Headspace Vial Domino is specifically designed to hold vials with an exterior diameter of ~23mm. It can hold up to 12 vials.

**SEE THIS DOMINO
ON OUR E-SHOP**

Agilent vial, screw top, headspace, clear, 20 mL, 23 x 75 mm



Manufacturer:
Agilent Technologies

Part number:
5188-2753

1-channel pipettes					
10 μ L	120 μ L	300 μ L	1000 μ L	5mL	10mL
✓	✓	✓	✓	✓	7 000

8-channel pipettes			
10 μ L	120 μ L	300 μ L	1200 μ L
✗	✗	✗	✗



Ø23MM HEADSPACE
VIAL DOMINO
PN: 186010578

Ordering product number

186010581

OneLab reference: [218.5641]

Ø27MM VIAL DOMINO



The Ø27mm Vial Domino is specifically designed to hold vials with an exterior diameter of ~27mm. It can hold up to 12 vials.

**SEE THIS DOMINO
ON OUR E-SHOP**

28mL (8 dram) Fisherbrand™ Glass vial



Manufacturer:
Fisher Scientific

Part number:
15364779

1-channel pipettes

10 μ L	120 μ L	300 μ L	1000 μ L	5mL	10mL
✓	✓	✓	✓	✓	✓

8-channel pipettes

10 μ L	120 μ L	300 μ L	1200 μ L
✗	✗	✗	✗



Ø27MM VIAL DOMINO
PN: 186010581

Ordering product number

186010299

OneLab reference: [218.4401]

Ø28MM TEST TUBE DOMINO



The Ø28mm Test Tube Domino is specifically designed to hold a growing array of test tubes with an exterior diameter of ~28mm. It can hold up to 8 tubes.

[SEE THIS DOMINO
ON OUR E-SHOP](#)

Lenz 28x150mm test tube with NS 24/29 socket



Manufacturer:
Lenz Laborglas

Part number:
5 7002 38

1-channel pipettes					
10 μ L	120 μ L	300 μ L	1000 μ L	5mL	10mL
15 000	5 000	5 000	✓	✓	✓

8-channel pipettes			
10 μ L	120 μ L	300 μ L	1200 μ L
✗	✗	✗	✗



Ø28MM TEST
TUBE DOMINO
PN: 186010299

Ordering product number

186010572

OneLab reference: [218.5161]

TILTED VIAL DOMINO



The Tilted Vial Domino is specifically designed to hold vials in a slightly tilted position (10° angle) to minimize dead volume when automating their use. It can hold up to 12 vials.

**SEE THIS DOMINO
ON OUR E-SHOP**

10 mL crimp-top glass vial



Manufacturer:
Associates of Cape
Cod, Inc.

Part number:
N/A

1-channel pipettes					
10 μ L	120 μ L	300 μ L	1000 μ L	5mL	10mL
✓	✓	✓	✓	⚠	⚠

8-channel pipettes			
10 μ L	120 μ L	300 μ L	1200 μ L
✗	✗	✗	✗



TILTED VIAL DOMINO
PN: 186010572

FOR BOTTLES

Ordering product number

186010304

OneLab reference: [218.4801]

Ø46MM BOTTLE DOMINO



The Ø46mm Bottle Domino is specifically designed to hold a growing array of bottles with an exterior diameter of ~46mm. It can hold up to 3 bottles.

[SEE THIS DOMINO
ON OUR E-SHOP](#)

DURAN® 50 mL amber glass laboratory bottle



Manufacturer:
DWK Life Sciences

Part number:
218061758

1-channel pipettes					
10µL	120µL	300µL	1000µL	5mL	10mL
✓	✓	✓	✓	✓	✓

8-channel pipettes			
10µL	120µL	300µL	1200µL
✗	✗	✗	✗



Ø46MM
BOTTLE DOMINO
PN: 186010304

Ordering product number

186010311

OneLab reference: [218.5281]

Ø51MM BOTTLE DOMINO



The ø51mm Bottle Domino is specifically designed to hold bottles with an exterior diameter of ~51mm. It can hold up to 4 bottles.

[SEE THIS DOMINO
ON OUR E-SHOP](#)

Qorpak™ 120 mL clear graduated medium round bottle



Manufacturer:

Qorpak

Part number:

GLC-01504

1-channel pipettes

10µL	120µL	300µL	1000µL	5mL	10mL
3 000	✓	✓	✓	✓	✓

8-channel pipettes

10µL	120µL	300µL	1200µL
✗	✗	✗	✗



Ø51MM BOTTLE DOMINO
PN: 186010311

Ordering product number

186010318

OneLab reference: [218.4431]

Ø55MM 10X BOTTLE DOMINO



The Ø55mm 10x Bottle Domino is specifically designed to hold up to 10 large-volume bottles. This Domino is a 1x2 format Domino. As of such, it takes 2 positions horizontally on the Andrew+ robot workbench.

[SEE THIS DOMINO
ON OUR E-SHOP](#)

DURAN® 100 mL clear glass laboratory bottle



Manufacturer:
DWK Life Sciences

Part number:
218012458

1-channel pipettes					
10µL	120µL	300µL	1000µL	5mL	10mL
✓	✓	✓	✓	✓	✓

8-channel pipettes			
10µL	120µL	300µL	1200µL
✗	✗	✗	✗



Ø55MM 10X
BOTTLE DOMINO
PN: 186010318

Ordering product number

186010175

OneLab reference: [218.3451]

NALGENE™ 15ML BOTTLE DOMINO



The Nalgene™ 15mL Bottle Domino is specifically designed to hold bottles bearing the same name. It can hold up to 12 bottles.

**SEE THIS DOMINO
ON OUR E-SHOP**

14mL (4 dram) Fisherbrand™ Glass vial



Manufacturer:
Fisher Scientific

Part number:
15354779

1-channel pipettes					
10µL	120µL	300µL	1000µL	5mL	10mL
✓	✓	✓	✓	✓	✓

8-channel pipettes			
10µL	120µL	300µL	1200µL
✗	✗	✗	✗



NALGENEX™ 15ML
BOTTLE DOMINO
PN: 186010175

Nalgene™ 15 mL HDPE diagnostic bottle



Manufacturer:
Nalgene

Part number:
342002-9050

1-channel pipettes					
10µL	120µL	300µL	1000µL	5mL	10mL
✓	✓	✓	✓	✓	✓

8-channel pipettes			
10µL	120µL	300µL	1200µL
✗	✗	✗	✗



**NALGENE™ 15ML
BOTTLE DOMINO**
PN: 186010175

Ordering product number

186010176

OneLab reference: [218.3481]

NALGENE™ 60ML BOTTLE DOMINO



The Nalgene™ 60mL Bottle Domino is specifically designed to hold bottles bearing the same name. It can hold up to 6 bottles.

**SEE THIS DOMINO
ON OUR E-SHOP**

Nalgene™ 60 mL narrow-mouth HDPE bottle



Manufacturer:
Nalgene

Part number:
342089-0002

1-channel pipettes					
10µL	120µL	300µL	1000µL	5mL	10mL
✓	✓	✓	✓	✓	✓

8-channel pipettes			
10µL	120µL	300µL	1200µL
✗	✗	✗	✗



**NALGENE™ 60ML
BOTTLE DOMINO**
PN: 186010176

Ordering product number

186010162

OneLab reference: [218.2871]

100ML BOTTLE MAGNETIC STIRRER DOMINO



The 100mL Bottle Stirrer Domino was developed for use with the V&P Scientific Multi Stirrus™ system, a rotary magnetic tumble stirrer (V&P Scientific, Inc, p/n VP 710D3 - not provided, to be purchased separately). The Multi Stirrus™ is not connected to OneLab and is therefore manually controlled by the user. It can hold and stir 2 bottles simultaneously in a single Domino position.

[SEE THIS DOMINO
ON OUR E-SHOP](#)

DURAN® 100 mL clear glass laboratory bottle



Manufacturer:
DWK Life Sciences

Part number:
218012458

1-channel pipettes					
10µL	120µL	300µL	1000µL	5mL	10mL
✓	✓	✓	✓	✓	✓

8-channel pipettes			
10µL	120µL	300µL	1200µL
✗	✗	✗	✗



100ML BOTTLE
MAGNETIC STIRRER
DOMINO
PN: 186010162

Ordering product number

186010177

OneLab reference: [218.3511]

NALGENE™ 125ML BOTTLE DOMINO



The Nalgene™ 125mL Bottle Domino is specifically designed to hold bottles bearing the same name. It can hold up to 4 bottles.

[SEE THIS DOMINO
ON OUR E-SHOP](#)

Nalgene™ 125 mL narrow-mouth HDPE bottle



Manufacturer:
Nalgene

Part number:
342089-0004

1-channel pipettes					
10µL	120µL	300µL	1000µL	5mL	10mL
✓	✓	✓	✓	✓	✓

8-channel pipettes			
10µL	120µL	300µL	1200µL
✗	✗	✗	✗



NALGENE™ 125ML
BOTTLE DOMINO
PN: 186010177

Ordering product number

186010300

OneLab reference: [218.5551]

125ML STORAGE BOTTLE DOMINO



The 125mL Storage Bottle Domino is designed to hold 2 round bottles in a single Domino position.

**SEE THIS DOMINO
ON OUR E-SHOP**

Costar® 125 mL Traditional Style Polystyrene Storage Bottle



Manufacturer:
Corning Inc.

Part number:
8388

1-channel pipettes					
10 μ L	120 μ L	300 μ L	1000 μ L	5mL	10mL
✓	✓	✓	✓	✓	✓

8-channel pipettes			
10 μ L	120 μ L	300 μ L	1200 μ L
✗	✗	✗	✗



**125ML STORAGE
BOTTLE DOMINO**
PN: 186010300

Ordering product number

186010301

OneLab reference: [218.5581]

125ML SQUARE BOTTLE DOMINO



The 125mL Square Bottle Domino is designed to hold 2 square bottles in a single Domino position.

**SEE THIS DOMINO
ON OUR E-SHOP**

Nalgene 125mL bottle



Manufacturer:
Thermo Scientific

Part number:
0339072

1-channel pipettes					
10 μ L	120 μ L	300 μ L	1000 μ L	5mL	10mL
✓	✓	✓	✓	✓	✓

8-channel pipettes			
10 μ L	120 μ L	300 μ L	1200 μ L
✗	✗	✗	✗



125ML SQUARE BOTTLE
DOMINO
PN: 186010301

Ordering product number

186010197

OneLab reference: [218.3801]

NALGENE™ 175ML BOTTLE DOMINO



The Nalgene™ 175mL Bottle Domino is specifically designed to hold bottles bearing the same name. It can hold up to 4 square bottles.

[SEE THIS DOMINO
ON OUR E-SHOP](#)

Nalgene™ 175 mL square wide-mouth HDPE bottle



Manufacturer:
Nalgene

Part number:
312114-0006

1-channel pipettes					
10µL	120µL	300µL	1000µL	5mL	10mL
✓	✓	✓	✓	✓	✓

8-channel pipettes			
10µL	120µL	300µL	1200µL
✗	✗	✗	✗



NALGENE™ 175ML
BOTTLE DOMINO
PN: 186010197

Ordering product number

186010193

OneLab reference: [218.3701]

250ML DURAN BOTTLE DOMINO



The 250mL Duran Bottle Domino is designed to hold 2, large-volume bottles in a single Domino position.

**SEE THIS DOMINO
ON OUR E-SHOP**

DURAN® 250 mL clear glass laboratory bottle



Manufacturer:
DWK Life Sciences

Part number:
218013651

1-channel pipettes					
10µL	120µL	300µL	1000µL	5mL	10mL
70 000	✓	✓	✓	✓	✓

8-channel pipettes			
10µL	120µL	300µL	1200µL
✗	✗	✗	✗



**250ML DURAN
BOTTLE DOMINO**
PN: 186010193

Normax, 250 mL screw-cap laboratory bottle



Manufacturer:
Normax

Part number:
3.21801365

1-channel pipettes					
10 μ L	120 μ L	300 μ L	1000 μ L	5mL	10mL
70 000	✓	✓	✓	✓	✓

8-channel pipettes			
10 μ L	120 μ L	300 μ L	1200 μ L
✗	✗	✗	✗



250ML DURAN
BOTTLE DOMINO
PN: 186010193

Ordering product number

186010090

OneLab reference: [218.2751]

500ML ROUND BOTTLE DOMINO



The 500mL Round Bottle Domino is designed to hold a single, 500mL bottle. Ideal for workflows requiring large-volumes of reagent and/or buffers.

[SEE THIS DOMINO
ON OUR E-SHOP](#)

Corning® 500 mL easy-grip storage bottle



Manufacturer:
Corning Inc.

Part number:
430282

1-channel pipettes					
10µL	120µL	300µL	1000µL	5mL	10mL
150 000	✓	✓	✓	✓	✓

8-channel pipettes			
10µL	120µL	300µL	1200µL
✗	✗	✗	✗



500ML ROUND
BOTTLE DOMINO
PN: 186010090

PYREX[®] 500 mL wide-mouth storage bottle



Manufacturer:
Corning Inc.

Part number:
1397-500

1-channel pipettes					
10 μ L	120 μ L	300 μ L	1000 μ L	5mL	10mL
✓	✓	✓	✓	✓	✓

8-channel pipettes			
10 μ L	120 μ L	300 μ L	1200 μ L
✗	✗	✗	✗



**500ML ROUND
BOTTLE DOMINO**
PN: 186010090

Ordering product number

186010573

OneLab reference: [218.5221]

CONICAL BOTTOM 500ML TUBE DOMINO



The Conical Ø95mm Tube Domino is designed to hold a single, large-volume tube with a conical bottom in place on the Andrew+ workbench.

[SEE THIS DOMINO
ON OUR E-SHOP](#)

Corning® 500 mL conical centrifuge tube



Manufacturer:
Corning Inc.

Part number:
431123

1-channel pipettes					
10µL	120µL	300µL	1000µL	5mL	10mL
50 000	10 000	10 000	✓	✓	✓

8-channel pipettes			
10µL	120µL	300µL	1200µL
✗	✗	✗	✗



CONICAL BOTTOM
500ML TUBE DOMINO
PN: 186010573

**FOR OTHER
CONSUMABLE TYPES**

Ordering product number

186010579

OneLab reference: [218.5521]

SQUARE CUVETTE DOMINO



The Square Cuvette Domino is specifically designed to hold a growing variety of square cuvettes commonly used in UV spectrophotometry. It can hold up to 24 cuvettes.

**SEE THIS DOMINO
ON OUR E-SHOP**

1.6 mL Semi-Micro Cuvette



Manufacturer:
Greiner Bio-One

Part number:
613101

1-channel pipettes					
10 μ L	120 μ L	300 μ L	1000 μ L	5mL	10mL
✓	✓	✓	600	700	900

8-channel pipettes			
10 μ L	120 μ L	300 μ L	1200 μ L
✗	✗	✗	✗



SQUARE
CUVETTE DOMINO
PN: 186010579

4 mL Macro Cuvette



Manufacturer:
Greiner Bio-One

Part number:
614101

1-channel pipettes					
10 μ L	120 μ L	300 μ L	1000 μ L	5mL	10mL
✓	✓	✓	✓	✓	700

8-channel pipettes			
10 μ L	120 μ L	300 μ L	1200 μ L
✗	✗	✗	✗



SQUARE
CUVETTE DOMINO
PN: 186010579

BRAND™ UV-Cuvette Disposable Cuvet



Manufacturer:
Fisher Scientific

Part number:
759170

1-channel pipettes					
10µL	120µL	300µL	1000µL	5mL	10mL
✓	✓	✓	✓	✓	1 300

8-channel pipettes			
10µL	120µL	300µL	1200µL
✗	✗	✗	✗



**SQUARE
CUVETTE DOMINO**
PN: 186010579

Labelians PMMA 4mL Cuvette



Manufacturer:
Labelians

Part number:
CU4UV-1

1-channel pipettes					
10 μ L	120 μ L	300 μ L	1000 μ L	5mL	10mL
✓	✓	✓	✓	✓	✓

8-channel pipettes			
10 μ L	120 μ L	300 μ L	1200 μ L
✗	✗	✗	✗



SQUARE
CUVETTE DOMINO
PN: 186010579

Ordering product number

186010156

OneLab reference: [218.2122]

NUCLEOBOND XTRA MIDI COLUMN DOMINO



The NucleoBond Xtra Midi Column Domino is specifically designed to hold up to 3 columns bearing the same name. It is an indispensable component of the automated NucleoBond Xtra Midi Prep method on the Andrew+ Pipetting robot.

[SEE THIS DOMINO
ON OUR E-SHOP](#)

MACHEREY-NAGEL, NucleoBond Xtra Midi column



Manufacturer:
MACHEREY-NAGEL

Part number:
740410.10S



1-channel pipettes					
10 μ L	120 μ L	300 μ L	1000 μ L	5mL	10mL
✓	✓	✓	✓	✓	✓

8-channel pipettes			
10 μ L	120 μ L	300 μ L	1200 μ L
✗	✗	✗	✗



**NUCLEOBOND XTRA
MIDI COLUMN DOMINO**
PN: 186010156

COOLED DOMINOS

**FOR PLATES
AND RESERVOIRS**

Ordering product number

186010189

OneLab reference: [218.2481]

96-PCR PLATE COOLED DOMINO

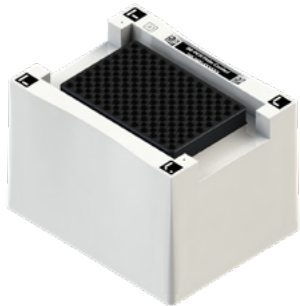

The 96-PCR Plate Cooled Domino is designed to hold specific 96-format plates for optimal cooling efficiency. The passive cooling technology of this Domino can keep the contents of plates cooled at $\sim 4^{\circ}$ for about 5 hours.

**SEE THIS DOMINO
ON OUR E-SHOP**

Axygen® 96-well PCR white microplate



Manufacturer:
Starlab

Part number:
PCR-96-LC480-W-NF

1-channel pipettes					
10µL	120µL	300µL	1000µL	5mL	10mL
✓	✓	✓	✓	40	60

8-channel pipettes			
10µL	120µL	300µL	1200µL
✓	✓	✓	✓



96-PCR PLATE
COOLED DOMINO
PN: 186010189

Thermo Scientific™ 96-well non-skirted PCR plate



Manufacturer:
Thermo Scientific

Part number:
AB0600

1-channel pipettes					
10 μ L	120 μ L	300 μ L	1000 μ L	5mL	10mL
✓	✓	✓	✓	✗	✗

8-channel pipettes			
10 μ L	120 μ L	300 μ L	1200 μ L
✓	✓	✓	✓



96-PCR PLATE
COOLED DOMINO
PN: 186010189

Ordering product number

186010196

OneLab reference: [218.3761]

384-PCR PLATE COOLED DOMINO

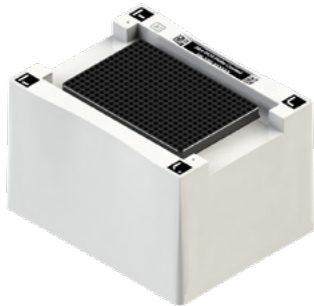

The 384-PCR Plate Cooled Domino is designed to hold specific 384-format plates for optimal cooling efficiency. The passive cooling technology of this Domino can keep the contents of plates cooled at $\sim 4^{\circ}$ for about 5 hours.

**SEE THIS DOMINO
ON OUR E-SHOP**

Armadillo 384-well PCR plate, red



Manufacturer:
Thermo Scientific

Part number:
AB3384R

1-channel pipettes					
10 μ L	120 μ L	300 μ L	1000 μ L	5mL	10mL
✓	✓	✓	✓	✗	✗

8-channel pipettes			
10 μ L	120 μ L	300 μ L	1200 μ L
✓	✓	✓	10



384-PCR PLATE
COOLED DOMINO
PN: 186010196

MicroAmp™ 40 µL optical 384-well skirted reaction plate w/ barcode



Manufacturer:
Applied Biosystems

Part number:
4309849

1-channel pipettes					
10µL	120µL	300µL	1000µL	5mL	10mL
✓	✓	✓	⚠	⚠	✗

8-channel pipettes			
10µL	120µL	300µL	1200µL
✓	✓	✓	⚠



384-PCR PLATE
COOLED DOMINO
PN: 186010196

Ordering product number

186010169

OneLab reference: [218.3191]

8-CHANNEL RESERVOIR COOLED DOMINO



The 8-Channel Reservoir Cooled Domino is designed to hold specific 8-channel reservoirs for optimal cooling efficiency. The passive cooling technology of this Domino can keep the contents of the reservoirs it holds at $\sim 4^{\circ}$ for about 5 hours. It can hold up to 2, 10mL reservoirs.

**SEE THIS DOMINO
ON OUR E-SHOP**

INTEGRA 10 mL multichannel reservoir



Manufacturer:
INTEGRA Biosciences

Part number:
4332

1-channel pipettes					
10 μ L	120 μ L	300 μ L	1000 μ L	5mL	10mL
✓	✓	✓	✓	✓	✓

8-channel pipettes			
10 μ L	120 μ L	300 μ L	1200 μ L
1 000	✓	✓	✓



8-CHANNEL RESERVOIR
COOLED DOMINO
PN: 186010169

FOR TUBES AND VIALS

Ordering product number

186010315

OneLab reference: [218.4501]

0.5ML MICROTUBE COOLED DOMINO



The 0.5mL Microtube Cooled Domino is designed to hold specific 0.5mL microtubes for optimal cooling efficiency. The passive cooling technology of this Domino can keep the contents of up to 15 microtubes cooled at $\sim 4^{\circ}$ for about 5 hours.

**SEE THIS DOMINO
ON OUR E-SHOP**

Eppendorf 0.5 mL protein LoBind® microtube



Manufacturer:
Eppendorf

Part number:
0030108094

1-channel pipettes					
10µL	120µL	300µL	1000µL	5mL	10mL
40	✓	✓	40	🧪	🧪

8-channel pipettes			
10µL	120µL	300µL	1200µL
✗	✗	✗	✗



0.5ML MICROTUBE
COOLED DOMINO
PN: 186010315

Ordering product number

186010188

OneLab reference: [218.2451]

1.5ML MICROTUBE COOLED DOMINO



The 1.5mL Microtube Cooled Domino is designed to hold specific microtubes for optimal cooling efficiency. The passive cooling technology of this Domino can keep the contents of up to 15 microtubes cooled at $\sim 4^{\circ}$ for about 5 hours.

**SEE THIS DOMINO
ON OUR E-SHOP**

Eppendorf 1.5 mL Safe-Lock tube



Manufacturer:
Eppendorf

Part number:
0030120086

1-channel pipettes					
10 μ L	120 μ L	300 μ L	1000 μ L	5mL	10mL
✓	✓	✓	✓	✓	⚠

8-channel pipettes			
10 μ L	120 μ L	300 μ L	1200 μ L
✗	✗	✗	✗



1.5ML MICROTUBE
COOLED DOMINO
PN: 186010188

Fisherbrand™ Premium 1.5 mL microtube



Manufacturer:
Fisher Scientific

Part number:
11926955

1-channel pipettes					
10µL	120µL	300µL	1000µL	5mL	10mL
✓	✓	✓	✓	✓	⚠

8-channel pipettes			
10µL	120µL	300µL	1200µL
✗	✗	✗	✗



**1.5ML MICROTUBE
COOLED DOMINO**
PN: 186010188

Sarstedt, 1.5 mL conical microtube



Manufacturer:
Sarstedt

Part number:
72.690.001

1-channel pipettes					
10 μ L	120 μ L	300 μ L	1000 μ L	5mL	10mL
✓	✓	✓	✓	✓	⚠

8-channel pipettes			
10 μ L	120 μ L	300 μ L	1200 μ L
✗	✗	✗	✗



1.5ML MICROTUBE
COOLED DOMINO
PN: 186010188

Ordering product number

186010314

OneLab reference: [218.4471]

2ML MICROTUBE COOLED DOMINO



The 2mL Microtube Cooled Domino is designed to hold specific 2mL microtubes for optimal cooling efficiency. The passive cooling technology of this Domino can keep the contents of up to 15 microtubes cooled at $\sim 4^{\circ}$ for about 5 hours.

**SEE THIS DOMINO
ON OUR E-SHOP**

Sarstedt, 2 mL screw-cap microtube



Manufacturer:
Sarstedt

Part number:
72.664

1-channel pipettes					
10 μ L	120 μ L	300 μ L	1000 μ L	5mL	10mL
✓	✓	✓	✓	1 000	1 000

8-channel pipettes			
10 μ L	120 μ L	300 μ L	1200 μ L
✗	✗	✗	✗



2ML MICROTUBE
COOLED DOMINO
PN: 186010314

Ordering product number

186010187

OneLab reference: [218.2421]

15ML TUBE COOLED DOMINO



The 15mL Tube Cooled Domino is designed to hold specific 15mL tubes for optimal cooling efficiency. The passive cooling technology of this Domino can keep the contents of up to 10 tubes cooled at $\sim 4^{\circ}$ for about 5 hours.

**SEE THIS DOMINO
ON OUR E-SHOP**

Falcon® 15 mL conical centrifuge tube



Manufacturer:
Corning Inc.

Part number:
352096

1-channel pipettes					
10µL	120µL	300µL	1000µL	5mL	10mL
4 000	1 000	1 000	✓	✓	1 500

8-channel pipettes			
10µL	120µL	300µL	1200µL
✗	✗	✗	✗



15ML TUBE COOLED
DOMINO
PN: 186010187

Ordering product number

186010158

OneLab reference: [218.2541]

50ML TUBE COOLED DOMINO



The 50mL Tube Cooled Domino is designed to hold specific 50mL tubes for optimal cooling efficiency. The passive cooling technology of this Domino can keep the contents of up to 6 tubes cooled at $\sim 4^{\circ}$ for about 5 hours.

**SEE THIS DOMINO
ON OUR E-SHOP**

Corning® 50 mL conical centrifuge tube



Manufacturer:
Corning Inc.

Part number:
430290

1-channel pipettes					
10 μ L	120 μ L	300 μ L	1000 μ L	5mL	10mL
✓	✓	✓	✓	✓	✓

8-channel pipettes			
10 μ L	120 μ L	300 μ L	1200 μ L
✗	✗	✗	✗



50ML TUBE
COOLED DOMINO
PN: 186010158

Falcon® 50 mL conical centrifuge tube



Manufacturer:
Corning Inc.

Part number:
352070

1-channel pipettes					
10 μ L	120 μ L	300 μ L	1000 μ L	5mL	10mL
✓	✓	✓	✓	✓	✓

8-channel pipettes			
10 μ L	120 μ L	300 μ L	1200 μ L
✗	✗	✗	✗



50ML TUBE
COOLED DOMINO
PN: 186010158

Nunc™ 50 mL conical centrifuge tube



Manufacturer:
Thermo Scientific

Part number:
339652

1-channel pipettes					
10µL	120µL	300µL	1000µL	5mL	10mL
✓	✓	✓	✓	✓	✓

8-channel pipettes			
10µL	120µL	300µL	1200µL
✗	✗	✗	✗



50ML TUBE
COOLED DOMINO
PN: 186010158

VWR® 50 mL conical centrifuge tube



Manufacturer:
VWR International

Part number:
525-0610

1-channel pipettes					
10µL	120µL	300µL	1000µL	5mL	10mL
✓	✓	✓	✓	✓	✓

8-channel pipettes			
10µL	120µL	300µL	1200µL
✗	✗	✗	✗



50ML TUBE
COOLED DOMINO
PN: 186010158

RACK DOMINOS

**COLLECTION LABWARE
RACK DOMINO**

Ordering product number

186010523

OneLab reference: [218.4611]

COLLECTION LABWARE RACK DOMINO

DIRECT COMPATIBILITY



The Collection Rack Domino is compatible with an expanding range of Collection Racks. It enables fully automated SPE workflows by allowing automated consumable movements to and from the Extraction+ manifold base by the Andrew+ robot equipped with the Microplate Gripper Tool.

**SEE THIS DOMINO
ON OUR E-SHOP**

ArcticWhite, 290 mL single cavity reservoir



Manufacturer:
ArcticWhite LLC

Part number:
AWLS-S30017



1-channel pipettes

10 μ L	120 μ L	300 μ L	1000 μ L	5mL	10mL
✓	✓	✓	✓	✓	✓

8-channel pipettes

10 μ L	120 μ L	300 μ L	1200 μ L
✓	✓	✓	✓



COLLECTION LABWARE
RACK DOMINO
Direct Compatibility
186010523

Axygen® 96 V-bottom single well reservoir



Manufacturer:
Corning Inc.

Part number:
RES-SW96-HP-SI



1-channel pipettes					
10µL	120µL	300µL	1000µL	5mL	10mL
✓	✓	✓	✓	✓	✓

8-channel pipettes			
10µL	120µL	300µL	1200µL
✓	✓	✓	✓



COLLECTION LABWARE
RACK DOMINO
Direct Compatibility
186010523

Ordering product number
186010523
OneLab reference: [218.4611]

COLLECTION LABWARE RACK DOMINO

EQUIPPED WITH 0.2ML MICROTUBE RACK (requires 186010303)

24X

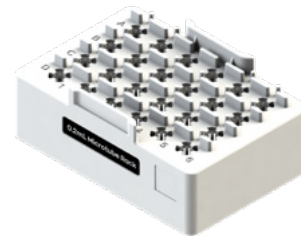
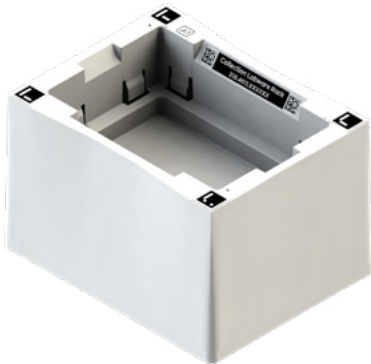

0.2mL Microtube Rack Domino
OneLab reference: [218.5071]



IMPORTANT

Compatibility of the 0.2mL Microtube Rack with the Collection Labware Rack Domino requires the purchase of the 0.2mL Microtube Rack Domino bundle (186010303).

Thermo Scientific™ 0.2 mL PCR microtube, racked



Manufacturer:
Thermo Scientific

Part number:
AB0620

1-channel pipettes					
10 μ L	120 μ L	300 μ L	1000 μ L	5mL	10mL
✓	✓	✓	50	⚠	⚠

8-channel pipettes			
10 μ L	120 μ L	300 μ L	1200 μ L
✗	✗	✗	✗

COLLECTION LABWARE
RACK DOMINO
Equipped with
0.2mL Microtube Rack
PN: 186010523
+ 186010534



Ordering product number

186010523

OneLab reference: [218.4611]

COLLECTION LABWARE RACK DOMINO

EQUIPPED WITH 4ML VIAL COLLECTION RACK

24X



Ordering product number

186011193



4mL Vial Collection Rack

OneLab reference: [519.2800]



Clear Glass 4 mL Screw Neck Vial, racked



SEE THIS CONSUMABLE
ON OUR E-SHOP

Manufacturer:
Waters Corporation

Part number:
186000840

1-channel pipettes

10 μ L	120 μ L	300 μ L	1000 μ L	5mL	10mL
✓	✓	✓	✓	1 500	2 700

8-channel pipettes

10 μ L	120 μ L	300 μ L	1200 μ L
✗	✗	✗	✗



+



COLLECTION LABWARE
RACK DOMINO
Equipped with
4mL Vial Collection Rack
PN: 186010523
+ 186011193

Ordering product number

186010523

OneLab reference: [218.4611]

COLLECTION LABWARE RACK DOMINO

EQUIPPED WITH THE 5ML TUBE COLLECTION RACK



Ordering product number

186010534

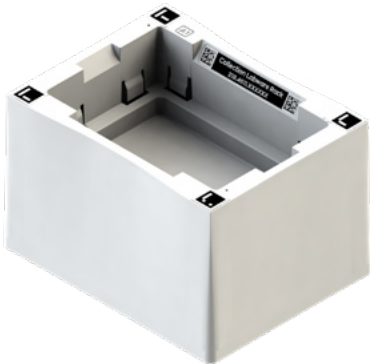

5mL Tube Collection Rack

OneLab reference: [519.2651]



IMPORTANT

The 5mL Tube Collection Rack (12-position rack) is manufactured by Waters Corporation and specifically designed for use with the **Extraction+** connected device. The 5mL Tube Collection Rack is sold separately from the Collection Labware Rack Domino. It is only supplied with the Collection Labware Rack Domino in the case of the Extraction+ 6cc Cartridge Kit (176005206).

VWR® 5 mL snap-cap centrifuge tube, racked



Manufacturer:
VWR International

Part number:
10002-728

1-channel pipettes					
10µL	120µL	300µL	1000µL	5mL	10mL
✓	✓	✓	✓	✓	✓

8-channel pipettes			
10µL	120µL	300µL	1200µL
✗	✗	✗	✗



COLLECTION LABWARE
RACK DOMINO
Compatibility via
5mL Tube Collection Rack
PN: 186010523
+ 186010534

Ordering product number

186010523

OneLab reference: [218.4611]

COLLECTION LABWARE RACK DOMINO

EQUIPPED WITH Ø12MM VIAL COLLECTION RACK

24X

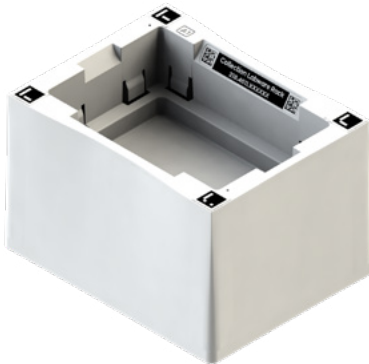

Ordering product number

186010531



Ø12mm Vial Collection Rack

OneLab reference: [519.2601]



IMPORTANT

The Ø12mm Vial Collection Rack (24-position rack) is manufactured by Waters Corporation and specifically designed for use with the **Extraction+** connected device. The Ø12mm Vial Collection Rack is sold separately from the Collection Labware Rack Domino. It is only supplied with the Collection Labware Rack Domino in the case of the Extraction+ 1cc and 3cc Cartridge Kits (176005204 & 176005205).

Waters 2 mL 12x32 mm LC/GC screw-top vial, racked



SEE THIS CONSUMABLE
ON OUR E-SHOP

Manufacturer:
Waters Corporation

Part number:
186000272C

1-channel pipettes					
10 μ L	120 μ L	300 μ L	1000 μ L	5mL	10mL
✓	✓	✓	1 000	🚫	🚫

8-channel pipettes			
10 μ L	120 μ L	300 μ L	1200 μ L
✗	✗	✗	✗

COLLECTION LABWARE
RACK DOMINO
Equipped with
 \varnothing 12mm Vial Collection Rack
PN: 186010523
+ 186010531



Waters 300 μ L 12x32mm screw neck vial, racked



SEE THIS CONSUMABLE
ON OUR E-SHOP

Manufacturer:
Waters Corporation

Part number:
186002639

1-channel pipettes					
10 μ L	120 μ L	300 μ L	1000 μ L	5mL	10mL
✓	✓	✓	150	🚫	🚫

8-channel pipettes			
10 μ L	120 μ L	300 μ L	1200 μ L
✗	✗	✗	✗

COLLECTION LABWARE
RACK DOMINO
Equipped with
 \varnothing 12mm Vial Collection Rack
PN: 186010523
+ 186010531



Waters 700 μ L 12x32mm screw neck vial, racked



SEE THIS CONSUMABLE
ON OUR E-SHOP

Manufacturer:
Waters Corporation

Part number:
186005221

1-channel pipettes					
10 μ L	120 μ L	300 μ L	1000 μ L	5mL	10mL
✓	✓	✓	500	🧪	🧪

8-channel pipettes			
10 μ L	120 μ L	300 μ L	1200 μ L
✗	✗	✗	✗

COLLECTION LABWARE
RACK DOMINO
Equipped with
 \varnothing 12mm Vial Collection Rack
PN: 186010523
+ 186010531



Waters QuanRecovery™ 300 µL 12x32mm screw neck vial, racked



Manufacturer:
Waters Corporation

Part number:
186009186

SEE THIS CONSUMABLE
ON OUR E-SHOP

1-channel pipettes					
10µL	120µL	300µL	1000µL	5mL	10mL
✓	✓	✓	150	⚠	⚠

8-channel pipettes			
10µL	120µL	300µL	1200µL
✗	✗	✗	✗



COLLECTION LABWARE
RACK DOMINO
Equipped with
ø12mm Vial Collection Rack
PN: 186010523
+ 186010531

Ordering product number

186010523

OneLab reference: [218.4611]

COLLECTION LABWARE RACK DOMINO

EQUIPPED WITH 10ML VIAL COLLECTION RACK

8X

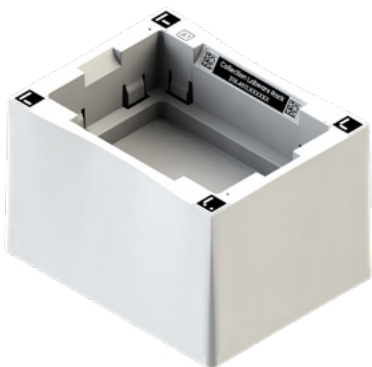

+

Ordering product number

186111118



>



10mL Vial Collection Rack

OneLab reference: [519.274]



IMPORTANT

The 10mL Vial Collection Rack is manufactured by Waters and is specifically designed for use with the **Extraction+** Connected Device. The 10mL Vial Collection Rack is sold separately from the Collection Labware Rack Domino. It is only supplied with the Collection Labware Rack Domino in the case of the Extraction+ 6cc - 8 position cartridge kit 176005433)

WHEATON® 10 mL clear glass serum vial, racked



Manufacturer:
DWK Life Sciences

Part number:
223686

1-channel pipettes					
10µL	120µL	300µL	1000µL	5mL	10mL
✓	✓	✓	✓	✓	✓

8-channel pipettes			
10µL	120µL	300µL	1200µL
✗	✗	✗	✗



COLLECTION LABWARE
RACK DOMINO
Equipped with
10mL Vial Collection Rack
PN: 186010523
+ 186111118

Ordering product number

186010523

OneLab reference: [218.4611]

COLLECTION LABWARE RACK DOMINO

EQUIPPED WITH CRYOVIAL COLLECTION RACK

24X

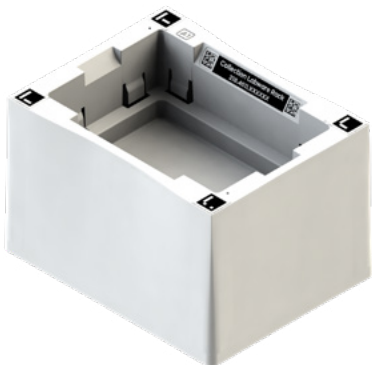

Ordering product number

186011194



Cryovial Collection Rack

OneLab reference: [518.3433]



2mL cryovial with Inner Thread, in 24 position rack



Manufacturer:

Biozym

Part number:

710522

1-channel pipettes					
10 μ L	120 μ L	300 μ L	1000 μ L	5mL	10mL
✓	✓	✓	✓	✓	✓

8-channel pipettes			
10 μ L	120 μ L	300 μ L	1200 μ L
✗	✗	✗	✗



COLLECTION LABWARE
RACK DOMINO
Equipped with
Cryovial Collection Rack
PN: 186010523
+ 186011194

Ordering product number

186010305

OneLab reference: [218.4641]

RACKED TUBES DOMINO

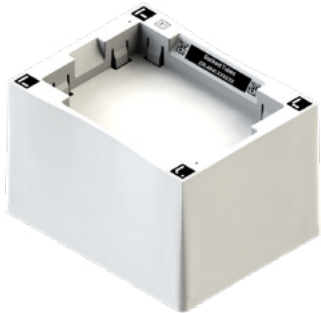

The Racked Tubes Domino is designed to hold various types of tubes that are positioned within existing storage racks. The Racked Tubes Domino holds these racks in place rather than the individual tubes themselves. As of such, the number of tubes supported can vary.

**SEE THIS DOMINO
ON OUR E-SHOP**

Micronic 1.1 mL 2D-coded internal thread V-bottom tube in 96x rack



Manufacturer:
Micronic

Part number:
MP52318L

1-channel pipettes					
10 μ L	120 μ L	300 μ L	1000 μ L	5mL	10mL
✓	✓	✓	500	🚫	🚫

8-channel pipettes			
10 μ L	120 μ L	300 μ L	1200 μ L
✓	✓	✓	200



RACKED TUBES DOMINO
PN: 186010305

Micronic 1.4 mL 2D-coded internal thread V-bottom tube in 96x rack



Manufacturer:
Micronic

Part number:
MP52353L

1-channel pipettes					
10 μ L	120 μ L	300 μ L	1000 μ L	5mL	10mL
✓	✓	✓	800	🚫	🚫

8-channel pipettes			
10 μ L	120 μ L	300 μ L	1200 μ L
✓	✓	✓	300



RACKED TUBES DOMINO
PN: 186010305

Micronic 1.4mL Round Bottom Tubes



Manufacturer:
Micronic

Part number:
MP32022

1-channel pipettes					
10 μ L	120 μ L	300 μ L	1000 μ L	5mL	10mL
✓	120	✓	600	600	800

8-channel pipettes			
10 μ L	120 μ L	300 μ L	1200 μ L
250	120	✓	✓



RACKED TUBES DOMINO
PN: 186010305

Micronic 3 mL 2D-coded external thread Flat-bottom tube in 48x rack



Manufacturer:
Micronic

Part number:
MP52861

1-channel pipettes					
10 μ L	120 μ L	300 μ L	1000 μ L	5mL	10mL
✓	✓	✓	✓	✓	400

8-channel pipettes			
10 μ L	120 μ L	300 μ L	1200 μ L
✗	✗	✗	✗



RACKED TUBES DOMINO
PN: 186010305

Ordering product number

186010303

OneLab reference: [218.5071]

0.2ML MICROTUBE RACK DOMINO BUNDLE

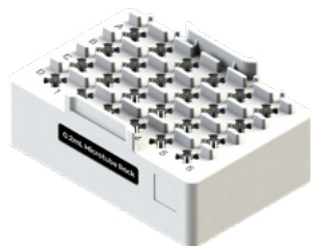
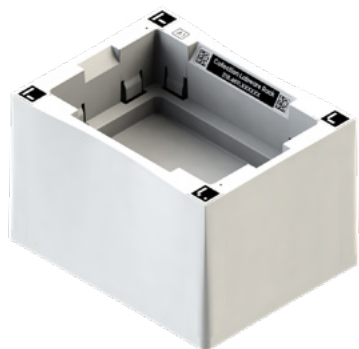

Ordering product number

186010303

Collection Labware Rack Domino

Ordering product number : 186010523

0.2 mL microtube 4x6 rack

Rack not sold separately

IMPORTANT

The 0.2mL Microtube Rack Domino bundle consists of two components:
The Collection Labware Rack Domino (186010523) and the 0.2 mL microtube 4x6 rack.

The 0.2mL microtube 4x6 rack cannot be purchased separately and is only supplied with the 0.2mL microtube Rack Domino bundle (186010303).

Thermo Scientific™ 0.2 mL PCR microtube, racked



Manufacturer:
Thermo Scientific

Part number:
AB0620



1-channel pipettes					
10µL	120µL	300µL	1000µL	5mL	10mL
✓	✓	✓	50	🚫	🚫

8-channel pipettes			
10µL	120µL	300µL	1200µL
✗	✗	✗	✗



**0.2ML MICROTUBE
RACK DOMINO BUNDLE**
PN: 186010303

Ordering product number

186010161

OneLab reference: [218.2841]

1.2ML MICROTUBE RACK DOMINO



The 1.2mL Microtube Rack Domino is specifically designed to hold a rack of 96 small-volume tubes.

**SEE THIS DOMINO
ON OUR E-SHOP**

STARLAB, 1.2 mL microtube in 96x rack



Manufacturer:
STARLAB

Part number:
I1412-0400

1-channel pipettes					
10 μ L	120 μ L	300 μ L	1000 μ L	5mL	10mL
✓	✓	✓	700	🧪	🧪

8-channel pipettes			
10 μ L	120 μ L	300 μ L	1200 μ L
✗	✗	✗	✗



**1.2ML MICROTUBE
RACK DOMINO**
PN: 186010161

Ordering product number

186010174

OneLab reference: [218.3421]

BRAND® 1.2ML MICROTUBE RACK DOMINO



The BRAND® 1.2mL Microtube Rack Domino, is specifically designed to hold the consumable and rack configuration bearing the same name. A single rack can hold up to 96 microtubes.

**SEE THIS DOMINO
ON OUR E-SHOP**

BRAND[®] 1.2 mL 8-strip tubes in 96x rack



Manufacturer:
BRAND

Part number:
781510

1-channel pipettes

10 μ L	120 μ L	300 μ L	1000 μ L	5mL	10mL
450	100	100	600		

8-channel pipettes

10 μ L	120 μ L	300 μ L	1200 μ L
450	100	100	450



BRAND[®] 1.2ML
MICROTUBE
RACK DOMINO
PN: 186010174

Ordering product number

186010178

OneLab reference: [218.3541]

2ML CRYOTUBE RACK DOMINO



The 2mL Cryotube Rack Domino is specifically designed to hold Cryotubes within a Waters 48x rack.

**SEE THIS DOMINO
ON OUR E-SHOP**

Cryo.s™ 2 mL external thread tube in Waters 48x holder



Manufacturer:
Greiner Bio-One

Part number:
126263

1-channel pipettes					
10µL	120µL	300µL	1000µL	5mL	10mL
✓	✓	✓	✓	✓	1 000

8-channel pipettes			
10µL	120µL	300µL	1200µL
✗	✗	✗	✗



**2ML CRYOTUBE
RACK DOMINO**
PN: 186010178

VWR® 2 mL free-standing cryogenic vial in Waters 48x holder



Manufacturer:
VWR International

Part number:
479-1208

1-channel pipettes					
10µL	120µL	300µL	1000µL	5mL	10mL
✓	✓	✓	✓	✓	1 000

8-channel pipettes			
10µL	120µL	300µL	1200µL
✗	✗	✗	✗



**2ML CRYOTUBE
RACK DOMINO**
PN: 186010178

Ordering product number

186010091

OneLab reference: [218.3001]

2ML HPLC VIAL RACK DOMINO



The 2mL HPLC Vial Rack Domino is designed to hold in place a growing variety of racks commonly used to hold HPLC vials in various formats.

**SEE THIS DOMINO
ON OUR E-SHOP**

Agilent 2 mL 12x32mm crimp-top vial in Genevac 48x holder



Manufacturer:
Agilent

Part number:
5181-3375

1-channel pipettes					
10 μ L	120 μ L	300 μ L	1000 μ L	5mL	10mL
✓	✓	✓	1 000	🚫	🚫

8-channel pipettes			
10 μ L	120 μ L	300 μ L	1200 μ L
✗	✗	✗	✗



2ML HPLC VIAL
RACK DOMINO
PN: 186010091

Agilent 2 mL 12x32mm crimp-top vial in Waters 48x holder



Manufacturer:
Agilent

Part number:
5181-3375

1-channel pipettes					
10 μ L	120 μ L	300 μ L	1000 μ L	5mL	10mL
✓	✓	✓	1 000	🚫	🚫

8-channel pipettes			
10 μ L	120 μ L	300 μ L	1200 μ L
✗	✗	✗	✗



2ML HPLC VIAL
RACK DOMINO
PN: 186010091

Agilent 2 mL 12x32mm screw-top vial in Vanquish™ rack



Manufacturer:
Agilent Technologies

Part number:
5182-0715

1-channel pipettes					
10µL	120µL	300µL	1000µL	5mL	10mL
✓	✓	✓	1 500	1 500	🚫

8-channel pipettes			
10µL	120µL	300µL	1200µL
✗	✗	✗	✗



2ML HPLC VIAL
RACK DOMINO
PN: 186010091

Agilent 12x32mm screw-top vial w/ 0.3 mL insert in Waters 48x holder



Manufacturer:
Agilent Technologies

Part number:
5188-6591

1-channel pipettes					
10 μ L	120 μ L	300 μ L	1000 μ L	5mL	10mL
35	✓	35	🚫	🚫	🚫

8-channel pipettes			
10 μ L	120 μ L	300 μ L	1200 μ L
✗	✗	✗	✗



2ML HPLC VIAL
RACK DOMINO
PN: 186010091

Fisherbrand™ 1.5mL Amber Snap Ring Glass Vial



Manufacturer:
Fisher Scientific

Part number:
11090645

1-channel pipettes					
10µL	120µL	300µL	1000µL	5mL	10mL
✓	✓	✓	1 000	🧪	🧪

8-channel pipettes			
10µL	120µL	300µL	1200µL
✗	✗	✗	✗



2ML HPLC VIAL
RACK DOMINO
PN: 186010091

Fisherbrand™ 1.5mL Clear Snap Ring Glass Vial



Manufacturer:
Fisher Scientific

Part number:
11535894

1-channel pipettes					
10µL	120µL	300µL	1000µL	5mL	10mL
✓	✓	✓	1 000	🧪	🧪

8-channel pipettes			
10µL	120µL	300µL	1200µL
✗	✗	✗	✗



2ML HPLC VIAL
RACK DOMINO
PN: 186010091

Fisherbrand™ 2 mL straight-sided shell vial in Waters 48x holder



Manufacturer:
Fisher Scientific

Part number:
03-339-26A

1-channel pipettes					
10µL	120µL	300µL	1000µL	5mL	10mL
✓	✓	✓	✓	✓	1 500

8-channel pipettes			
10µL	120µL	300µL	1200µL
✗	✗	✗	✗



**2ML HPLC VIAL
RACK DOMINO
PN: 186010091**

Interchim, 2 mL 12x32 mm screw-top glass vial in Waters 48x holder



Manufacturer:
Interchim

Part number:
723594

1-channel pipettes					
10 μ L	120 μ L	300 μ L	1000 μ L	5mL	10mL
✓	✓	✓	800	900	1 300

8-channel pipettes			
10 μ L	120 μ L	300 μ L	1200 μ L
✗	✗	✗	✗



2ML HPLC VIAL
RACK DOMINO
PN: 186010091

Sarstedt, 1.2 mL QuickSeal screw-cap cryotube in Waters 48x holder



Manufacturer:
Sarstedt

Part number:
72.377.007

1-channel pipettes					
10 μ L	120 μ L	300 μ L	1000 μ L	5mL	10mL
✓	✓	✓	✓	✓	✓

8-channel pipettes			
10 μ L	120 μ L	300 μ L	1200 μ L
✗	✗	✗	✗



2ML HPLC VIAL
RACK DOMINO
PN: 186010091

TPX snap/crimp-top vial w/ 0.2 mL glass micro-insert in Waters 48x holder



Manufacturer:
La-Pha-Pack GmbH

Part number:
11 14 1190

1-channel pipettes					
10 μ L	120 μ L	300 μ L	1000 μ L	5mL	10mL
20	20	40	200		

8-channel pipettes			
10 μ L	120 μ L	300 μ L	1200 μ L



2ML HPLC VIAL
RACK DOMINO
PN: 186010091

Verex™ screw-top clear glass v-Vial in Waters 48x holder



Manufacturer:
Phenomenex

Part number:
AR0-3940-12

1-channel pipettes					
10µL	120µL	300µL	1000µL	5mL	10mL
20	✓	✓	500	600	🧪

8-channel pipettes			
10µL	120µL	300µL	1200µL
✗	✗	✗	✗



2ML HPLC VIAL
RACK DOMINO
PN: 186010091

VWR® 1.2 mL internal thread cryogenic vial in Waters 48x holder



Manufacturer:
VWR International

Part number:
10018-738

1-channel pipettes					
10µL	120µL	300µL	1000µL	5mL	10mL
✓	✓	✓	✓	✓	✓

8-channel pipettes			
10µL	120µL	300µL	1200µL
✗	✗	✗	✗



2ML HPLC VIAL
RACK DOMINO
PN: 186010091

VWR® 1.5 mL short thread vial w/ wide opening in Waters 48x holder

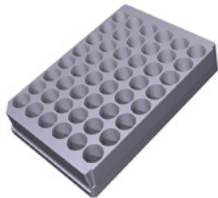

Manufacturer:
VWR International

Part number:
548-1848

1-channel pipettes					
10µL	120µL	300µL	1000µL	5mL	10mL
✓	✓	✓	1 500	1 500	🚫

8-channel pipettes			
10µL	120µL	300µL	1200µL
✗	✗	✗	✗



2ML HPLC VIAL
RACK DOMINO
PN: 186010091

Waters 1 mL deactivated total recovery vial in Waters 48x holder



SEE THIS CONSUMABLE
ON OUR E-SHOP

Manufacturer:
Waters Corporation

Part number:
186000234DV

1-channel pipettes					
10 μ L	120 μ L	300 μ L	1000 μ L	5mL	10mL
✓	✓	30	300	400	🧪

8-channel pipettes			
10 μ L	120 μ L	300 μ L	1200 μ L
✗	✗	✗	✗



2ML HPLC VIAL
RACK DOMINO
PN: 186010091

Waters 1 mL LC/GC screw-top vial in 48x holder

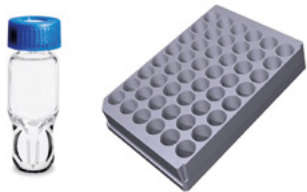

SEE THIS CONSUMABLE
ON OUR E-SHOP

Manufacturer:
Waters

Part number:
186000385C

1-channel pipettes					
10 μ L	120 μ L	300 μ L	1000 μ L	5mL	10mL
✓	✓	✓	200	200	🚫

8-channel pipettes			
10 μ L	120 μ L	300 μ L	1200 μ L
✗	✗	✗	✗



2ML HPLC VIAL
RACK DOMINO
PN: 186010091

Waters 2 mL 12x32 mm LC/GC screw-top vial in 48x holder

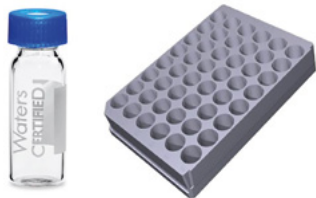

Manufacturer:
Waters

Part number:
186000272C

SEE THIS CONSUMABLE
ON OUR E-SHOP

1-channel pipettes

10 μ L	120 μ L	300 μ L	1000 μ L	5mL	10mL
✓	✓	✓	1 000	🧪	🧪

8-channel pipettes

10 μ L	120 μ L	300 μ L	1200 μ L
✗	✗	✗	✗



2ML HPLC VIAL
RACK DOMINO
PN: 186010091

Waters 2 mL deactivated amber glass screw-neck vial in 48x holder



Manufacturer:
Waters Corporation

Part number:
186000848DV

SEE THIS CONSUMABLE
ON OUR E-SHOP

1-channel pipettes

10 μ L	120 μ L	300 μ L	1000 μ L	5mL	10mL
✓	✓	✓	1 500	🚫	🚫

8-channel pipettes

10 μ L	120 μ L	300 μ L	1200 μ L
✗	✗	✗	✗



2ML HPLC VIAL
RACK DOMINO
PN: 186010091

Waters 300 μ L 12x32mm screw neck vial into 48x Waters rack



Manufacturer:
Waters Corporation

Part number:
186002639

SEE THIS CONSUMABLE
ON OUR E-SHOP

1-channel pipettes

10 μ L	120 μ L	300 μ L	1000 μ L	5mL	10mL
15	✓	✓	60	100	

8-channel pipettes

10 μ L	120 μ L	300 μ L	1200 μ L
✗	✗	✗	✗



2ML HPLC VIAL
RACK DOMINO
PN: 186010091

Waters 700 μL 12x32mm screw neck vial into Waters 48x rack



Manufacturer:
Waters Corporation

Part number:
186005221

SEE THIS CONSUMABLE
ON OUR E-SHOP

1-channel pipettes

10 μL	120 μL	300 μL	1000 μL	5mL	10mL
100	✓	✓	300	300	🧪

8-channel pipettes

10 μL	120 μL	300 μL	1200 μL
✗	✗	✗	✗



2ML HPLC VIAL
RACK DOMINO
PN: 186010091

Ordering product number

186010319

OneLab reference: [218.4671]

VIALS W/ 24X RACK DOMINO



This Domino is a configuration composed of both a Domino and a specific rack designed to hold up to 24 vials with an exterior diameter of ~17mm. The rack is NOT compatible with the microplate gripper tool.

**SEE THIS DOMINO
ON OUR E-SHOP**

5mL Neutral Type I glass diagnostic screw neck vial, racked



Manufacturer:
SCHOTT Pharma

Part number:
VCD005

1-channel pipettes

10 μ L	120 μ L	300 μ L	1000 μ L	5mL	10mL
✓	✓	✓	✓	2 000	4 000

8-channel pipettes

10 μ L	120 μ L	300 μ L	1200 μ L
✗	✗	✗	✗



VIALS W/ 24X
RACK DOMINO
PN: 186010319

Supelco, graduated 7 mL screw-top glass vial in 24x rack



Manufacturer:

Merck

Part number:

27025

1-channel pipettes					
10 μ L	120 μ L	300 μ L	1000 μ L	5mL	10mL
✓	✓	✓	✓	6 500	8 000

8-channel pipettes			
10 μ L	120 μ L	300 μ L	1200 μ L
✗	✗	✗	✗



VIALS W/ 24X
RACK DOMINO
PN: 186010319

Ordering product number

186010320

OneLab reference: [218.4711]

CULTURE TUBE W/ 48X RACK DOMINO



This Domino is a configuration composed of both a Domino and a specific rack designed to hold up to 48 vials with an exterior diameter of ~11.75mm. The rack is NOT compatible with the microplate gripper tool.

**SEE THIS DOMINO
ON OUR E-SHOP**

Disposable 6 mL culture tube with straight rim



CULTURE TUBE W/ 48X
RACK DOMINO
PN: 186010320

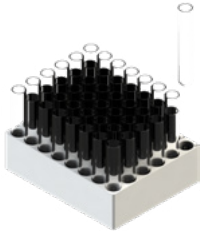

Manufacturer:
DWK Life Sciences

Part number:
231720862

1-channel pipettes

10 μ L	120 μ L	300 μ L	1000 μ L	5mL	10mL
✓	✓	✓	✓	✓	4 000

8-channel pipettes

10 μ L	120 μ L	300 μ L	1200 μ L
✗	✗	✗	✗

Ordering product number

186010321

OneLab reference: [218.5031]

15ML TUBE IN 15X RACK DOMINO



The 15mL Tube in 15x Rack Domino is specifically designed to hold a 3rd party rack (Cytiva: PN 28956404, sold separately) capable of holding up to 15 tubes.

**SEE THIS DOMINO
ON OUR E-SHOP**

Sarstedt, 15 mL conical tube in Cytiva 3x5 position cassette



Manufacturer:
Sarstedt

Part number:
62.554.001

Rack part number:
28956404

Rack sold separately

1-channel pipettes

10 μ L	120 μ L	300 μ L	1000 μ L	5mL	10mL
4 000	✓	✓	✓	✓	✓

8-channel pipettes

10 μ L	120 μ L	300 μ L	1200 μ L
✗	✗	✗	✗



**15ML TUBE IN 15X
RACK DOMINO
PN: 186010160**

Ordering product number

186010160

OneLab reference: [218.2811]

60X 15ML CENTRIFUGE TUBE RACK DOMINO



The 60x 15mL Centrifuge Tube Rack Domino is specifically design to hold various, third party racks capable of holding up to 60 tubes. This Domino is not sold with any accompanying racks. All compatible racks are sold separately by third party vendors. This Domino is a 1x2 format Domino. As of such, it takes 2 positions horizontally on the Andrew+ robot workbench.

**SEE THIS DOMINO
ON OUR E-SHOP**

14mL Polypropylene Test Tube into Agilent 60 positions rack

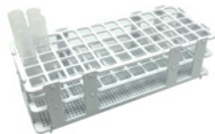

Manufacturer:
Agilent Technologies

Part number:
3710051100

Rack part number:
6610025400 - Agilent

Rack sold separately

1-channel pipettes

10 μ L	120 μ L	300 μ L	1000 μ L	5mL	10mL
5 000	2 000	2 000	✓	✓	✓

8-channel pipettes

10 μ L	120 μ L	300 μ L	1200 μ L
✗	✗	✗	✗



**60X 15ML CENTRIFUGE
TUBE RACK DOMINO**
PN: 186010160

Certifuge Tube 50mL into Agilent rack



Manufacturer:
Environmental
Express

Part number:
UC475-GN

Rack part number:
6610026600 - Agilent

Rack sold separately

1-channel pipettes

10 μ L	120 μ L	300 μ L	1000 μ L	5mL	10mL
✓	✓	✓	✓	✓	✓

8-channel pipettes

10 μ L	120 μ L	300 μ L	1200 μ L
✗	✗	✗	✗



**60X 15ML CENTRIFUGE
TUBE RACK DOMINO**
PN: 186010160

Falcon® 15 mL conical tube in Sapidyne 60x rack



Manufacturer:

Corning Inc.

Part number:

352096

Rack part number:

414045 - Sapidyne

Rack sold separately

1-channel pipettes

10µL	120µL	300µL	1000µL	5mL	10mL
1 500	600	900	✓	✓	500

8-channel pipettes

10µL	120µL	300µL	1200µL
✗	✗	✗	✗



**60X 15ML CENTRIFUGE
TUBE RACK DOMINO**
PN: 186010160

Ordering product number

186010514

OneLab reference: [218.4961]

50ML TUBE IN 55X RACK DOMINO

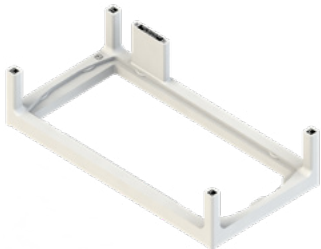

The 50mL Tube in 55x Rack Domino is specifically designed to hold a very large format rack capable of holding up to 55 tubes (Cytiva: PN 28980319, sold separately). This Domino is a 3x2 format Domino. As of such, it takes a total of 3 positions horizontally and 2 positions vertically on the Andrew+ robot workbench, equivalent to the space taken by 6 standard Dominos.

[SEE THIS DOMINO
ON OUR E-SHOP](#)

Sarstedt, 50 mL skirted conical tube in Cytiva 5x11 position rack



Manufacturer:
Sarstedt

Part number:
62.559.001

Rack part number:
28980319 - Cytiva

Rack sold separately

1-channel pipettes

10 μ L	120 μ L	300 μ L	1000 μ L	5mL	10mL
4 000	✓	✓	✓	✓	✓

8-channel pipettes

10 μ L	120 μ L	300 μ L	1200 μ L
✗	✗	✗	✗



**50ML TUBE
IN 55X RACK DOMINO
PN: 186010514**

Ordering product number

186010515

OneLab reference: [218.5001]

250ML BOTTLE IN 18X RACK DOMINO

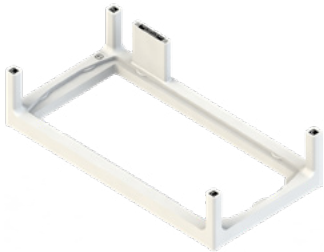

The 250mL Bottle in 18x Rack Domino is specifically designed to hold a very large format rack capable of holding up to 18 large bottles (Cytiva: PN 28981873, sold separately). This Domino is a 3x2 format Domino. As of such, it takes a total of 3 positions horizontally and 2 positions vertically on the Andrew+ robot workbench, equivalent to the space taken by 6 standard Dominos.

[SEE THIS DOMINO
ON OUR E-SHOP](#)

NOVOPLAST, 250 mL square bottle in Cytiva, 3x6 position rack



Manufacturer:
NOVOPLAST

Part number:
591.012.01.00

Rack part number:
28981873 - Cytiva

Rack sold separately

1-channel pipettes

10 μ L	120 μ L	300 μ L	1000 μ L	5mL	10mL
50 000	✓	✓	✓	✓	✓

8-channel pipettes

10 μ L	120 μ L	300 μ L	1200 μ L
✗	✗	✗	✗



**250ML BOTTLE
IN 18X RACK DOMINO
PN: 186010515**



DEVICE+



Ordering product number

176004577

OneLab reference: [518.4000]

MICROPLATE SHAKER+

DIRECT COMPATIBILITY



The Microplate Shaker+ is a OneLab connected device that uses market-leading orbital shaking technology to ensure vibration-free mixing speeds up to 3000rpm. A growing array of labware are compatible with this device either directly or via dedicated racks.

**SEE THIS DEVICE
ON OUR E-SHOP**

1.4mL Nova Biostorage tube into Matrix™ 2D rack



Manufacturer:
Thermo Scientific

Part number:
MP226RP

1-channel pipettes					
10µL	120µL	300µL	1000µL	5mL	10mL
✓	50	✓	600	600	800

8-channel pipettes			
10µL	120µL	300µL	1200µL
250	50	✓	✓



MICROPLATE SHAKER+
Direct Compatibility
PN: 176004577

Abgene™ 0.8 mL 96-deep well storage plate

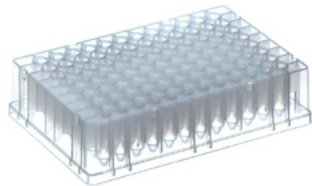

Manufacturer:
Thermo Scientific

Part number:
AB0859



1-channel pipettes					
10µL	120µL	300µL	1000µL	5mL	10mL
✓	✓	✓	50	200	40

8-channel pipettes			
10µL	120µL	300µL	1200µL
200	✓	✓	✓



MICROPLATE SHAKER+
Direct Compatibility
PN: 176004577

ACC, Pyroclear[®] Pyroplate[®] 96-well microplate

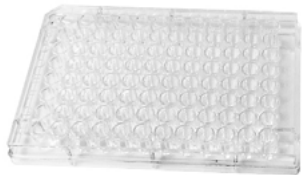

Manufacturer:
Associates of Cape
Cod, Inc.

Part number:
CA961-50



1-channel pipettes					
10 μ L	120 μ L	300 μ L	1000 μ L	5mL	10mL
✓	✓	✓	✓	⚠	⚠

8-channel pipettes			
10 μ L	120 μ L	300 μ L	1200 μ L
✓	✓	✓	✓



MICROPLATE SHAKER+
Direct Compatibility
PN: 176004577

Axygen® 1.1 mL 96-round deep well U-bottom plate



Manufacturer:
Corning Inc.

Part number:
P-DW-11-C



1-channel pipettes					
10µL	120µL	300µL	1000µL	5mL	10mL
✓	✓	✓	✓	✓	✓

8-channel pipettes			
10µL	120µL	300µL	1200µL
300	✓	✓	✓



MICROPLATE SHAKER+
Direct Compatibility
PN: 176004577

Azenta 0.9 mL external thread dual-coded tube in 96x rack



Manufacturer:
Azenta Life Sciences

Part number:
68-1001-11

1-channel pipettes					
10 μ L	120 μ L	300 μ L	1000 μ L	5mL	10mL
✓	✓	✓	600		

8-channel pipettes			
10 μ L	120 μ L	300 μ L	1200 μ L
500	✓	✓	✓



MICROPLATE SHAKER+
Direct Compatibility
PN: 176004577

CELLSTAR® 96-well clear F-bottom cell culture microplate

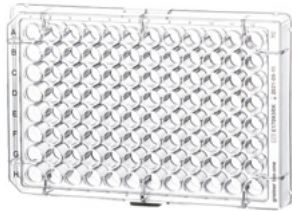

Manufacturer:
Greiner Bio-One

Part number:
655180



1-channel pipettes					
10µL	120µL	300µL	1000µL	5mL	10mL
✓	✓	✓	✓	⚠	⚠

8-channel pipettes			
10µL	120µL	300µL	1200µL
✓	✓	✓	✓



MICROPLATE SHAKER+
Direct Compatibility
PN: 176004577

Corning® 2 mL 96-square deep well V-bottom plate



Manufacturer:
Corning Inc.

Part number:
3960



1-channel pipettes					
10µL	120µL	300µL	1000µL	5mL	10mL
✓	✓	✓	✓	700	

8-channel pipettes			
10µL	120µL	300µL	1200µL
800	✓	✓	✓



MICROPLATE SHAKER+
Direct Compatibility
PN: 176004577

Eppendorf 0.5 mL 96-deep well protein LoBind® plate, yellow frame



Manufacturer:
Eppendorf

Part number:
0030504119



1-channel pipettes					
10µL	120µL	300µL	1000µL	5mL	10mL
✓	✓	✓	✓	✓	300

8-channel pipettes			
10µL	120µL	300µL	1200µL
300	✓	✓	✓



MICROPLATE SHAKER+
Direct Compatibility
PN: 176004577

Eppendorf 1 mL 96-deep well protein LoBind® plate, yellow frame



Manufacturer:
Eppendorf

Part number:
0030504216



1-channel pipettes

10µL	120µL	300µL	1000µL	5mL	10mL
✓	✓	✓	600	650	

8-channel pipettes

10µL	120µL	300µL	1200µL
500	✓	✓	✓



MICROPLATE SHAKER+
Direct Compatibility
PN: 176004577

Eppendorf 2 mL 96-square deep well plate, yellow frame



Manufacturer:
Eppendorf

Part number:
0030501314



1-channel pipettes					
10 μ L	120 μ L	300 μ L	1000 μ L	5mL	10mL
✓	✓	✓	✓	700	1 300

8-channel pipettes			
10 μ L	120 μ L	300 μ L	1200 μ L
500	✓	✓	✓



MICROPLATE SHAKER+
Direct Compatibility
PN: 176004577

Eppendorf twin.tec® 96-well skirted LoBind® PCR plate



Manufacturer:
Eppendorf

Part number:
0030129555



1-channel pipettes					
10µL	120µL	300µL	1000µL	5mL	10mL
✓	✓	✓	✓	⚠	⚠

8-channel pipettes			
10µL	120µL	300µL	1200µL
✓	✓	✓	✓



MICROPLATE SHAKER+
Direct Compatibility
PN: 176004577

FrameStar[®] 0.1 mL 96-well skirted low profile PCR plate, clear wells

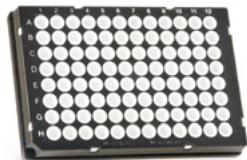

Manufacturer:
Azenta Life Sciences

Part number:
4ti-0960/RIG



1-channel pipettes					
10µL	120µL	300µL	1000µL	5mL	10mL
✓	✓	✓	✓	⚠	⚠

8-channel pipettes			
10µL	120µL	300µL	1200µL
✓	✓	✓	✓



MICROPLATE SHAKER+
Direct Compatibility
PN: 176004577

Greiner, 96-well PP U-bottom clear microplate



Manufacturer:
Greiner Bio-One

Part number:
650261

1-channel pipettes					
10 μ L	120 μ L	300 μ L	1000 μ L	5mL	10mL
✓	✓	✓	✓	✓	✓

8-channel pipettes			
10 μ L	120 μ L	300 μ L	1200 μ L
✓	✓	✓	✓



MICROPLATE SHAKER+
Direct Compatibility
PN: 176004577

Greiner, 96-well PS F-bottom clear microplate



Manufacturer:
Greiner Bio-One

Part number:
655101



1-channel pipettes					
10 μ L	120 μ L	300 μ L	1000 μ L	5mL	10mL
✓	✓	✓	✓	⚠	⚠

8-channel pipettes			
10 μ L	120 μ L	300 μ L	1200 μ L
✓	✓	✓	✓



MICROPLATE SHAKER+
Direct Compatibility
PN: 176004577

Hard-Shell[®] 96-well low-profile skirted PCR plate, white/clear



Manufacturer:
Bio-Rad

Part number:
HSP9601



1-channel pipettes					
10 μ L	120 μ L	300 μ L	1000 μ L	5mL	10mL
✓	✓	✓	✓	⚠	⚠

8-channel pipettes			
10 μ L	120 μ L	300 μ L	1200 μ L
✓	✓	✓	✓



MICROPLATE SHAKER+
Direct Compatibility
PN: 176004577

HardShell 96-well low-profile skirted PCR plate, blue/clear



Manufacturer:
PerkinElmer, Inc.

Part number:
6008870



1-channel pipettes					
10 μ L	120 μ L	300 μ L	1000 μ L	5mL	10mL
✓	✓	✓	✓	✗	✗

8-channel pipettes			
10 μ L	120 μ L	300 μ L	1200 μ L
✓	✓	✓	✓



MICROPLATE SHAKER+
Direct Compatibility
PN: 176004577

Matrix™ ScrewTop Tri-coded Tubes into 96 positions rack



Manufacturer:
Thermo Scientific

Part number:
3742-WP1D-BR



1-channel pipettes					
10µL	120µL	300µL	1000µL	5mL	10mL
✓	✓	✓	650	550	800

8-channel pipettes			
10µL	120µL	300µL	1200µL
✓	✓	✓	40



MICROPLATE SHAKER+
Direct Compatibility
PN: 176004577

MICROLON® 200 96-well U-bottom microplate

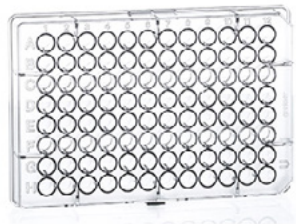

Manufacturer:
Greiner Bio-One

Part number:
650001

1-channel pipettes					
10µL	120µL	300µL	1000µL	5mL	10mL
✓	✓	✓	✓	⚠	⚠

8-channel pipettes			
10µL	120µL	300µL	1200µL
✓	✓	✓	✓



MICROPLATE SHAKER+
Direct Compatibility
PN: 176004577

MultiScreen® Solvinert™ 96-well filter plate, 0.45 µm pore size



Manufacturer:
Merck

Part number:
MSRLN0450

1-channel pipettes					
10µL	120µL	300µL	1000µL	5mL	10mL
✓	✓	✓	✓	⚠	⚠

8-channel pipettes			
10µL	120µL	300µL	1200µL
✓	✓	✓	✓



MICROPLATE SHAKER+
Direct Compatibility
PN: 176004577

Nunc™ 1.3 mL 96-DeepWell™ plate



Manufacturer:
Thermo Scientific

Part number:
260251



1-channel pipettes

10µL	120µL	300µL	1000µL	5mL	10mL
✓	✓	✓	✓	✓	✓

8-channel pipettes

10µL	120µL	300µL	1200µL
500	✓	✓	✓



MICROPLATE SHAKER+
Direct Compatibility
PN: 176004577

Nunc™ 2 mL 96-DeepWell™ plate



Manufacturer:
Thermo Scientific

Part number:
278743



1-channel pipettes					
10µL	120µL	300µL	1000µL	5mL	10mL
✓	✓	✓	✓	500	1 200

8-channel pipettes			
10µL	120µL	300µL	1200µL
500	✓	✓	✓



MICROPLATE SHAKER+
Direct Compatibility
PN: 176004577

Porvair, 2 mL 96-deep well U-bottom plate



Manufacturer:
Porvair Sciences

Part number:
219020



1-channel pipettes					
10 μ L	120 μ L	300 μ L	1000 μ L	5mL	10mL
✓	✓	✓	✓	1 000	1 500

8-channel pipettes			
10 μ L	120 μ L	300 μ L	1200 μ L
✓	✓	✓	✓



MICROPLATE SHAKER+
Direct Compatibility
PN: 176004577

PreDictor MabSelect SuRe, 50 μ L 96-Well Plate



Manufacturer:
Cytiva

Part number:
28925825



1-channel pipettes					
10 μ L	120 μ L	300 μ L	1000 μ L	5mL	10mL
✓	✓	✓	300	300	

8-channel pipettes			
10 μ L	120 μ L	300 μ L	1200 μ L
✓	✓	✓	✓



MICROPLATE SHAKER+
Direct Compatibility
PN: 176004577

Riplate® Medio 1mL Deepwell Plate



Manufacturer:
Carl Roth

Part number:
TC22.1

1-channel pipettes					
10µL	120µL	300µL	1000µL	5mL	10mL
✓	✓	✓	✓	✓	✓

8-channel pipettes			
10µL	120µL	300µL	1200µL
450	✓	✓	✓



MICROPLATE SHAKER+
Direct Compatibility
PN: 176004577

Thermo Scientific™ 0.3 mL 96-well U-bottom MaxiSorp Immuno plate



Manufacturer:
Thermo Scientific

Part number:
449824

1-channel pipettes					
10 μ L	120 μ L	300 μ L	1000 μ L	5mL	10mL
✓	✓	✓	✓	✓	✓

8-channel pipettes			
10 μ L	120 μ L	300 μ L	1200 μ L
✓	✓	✓	✓



MICROPLATE SHAKER+
Direct Compatibility
PN: 176004577

Thermo Scientific™ 400 µL Immuno Standard black 16-well strips in 96x plate



Manufacturer:
Thermo Scientific

Part number:
475515

1-channel pipettes					
10µL	120µL	300µL	1000µL	5mL	10mL
✓	✓	✓	✓	⚠	⚠

8-channel pipettes			
10µL	120µL	300µL	1200µL
✓	✓	✓	✓



MICROPLATE SHAKER+
Direct Compatibility
PN: 176004577

Waters 2 mL 96-square well collection plate, cut corner H1



SEE THIS CONSUMABLE
ON OUR E-SHOP

Manufacturer:
Waters

Part number:
186002482



Compatible with
Microplate
Gripper

1-channel pipettes

10 μ L	120 μ L	300 μ L	1000 μ L	5mL	10mL
✓	✓	✓	✓	300	850

8-channel pipettes

10 μ L	120 μ L	300 μ L	1200 μ L
✓	✓	✓	✓



MICROPLATE SHAKER+
Direct Compatibility
PN: 176004577

Waters 700 μ L 96-round well collection plate



SEE THIS CONSUMABLE
ON OUR E-SHOP

Manufacturer:
Waters

Part number:
186005837



1-channel pipettes					
10 μ L	120 μ L	300 μ L	1000 μ L	5mL	10mL
✓	✓	✓	100	100	

8-channel pipettes			
10 μ L	120 μ L	300 μ L	1200 μ L
200	✓	✓	✓



MICROPLATE SHAKER+
Direct Compatibility
PN: 176004577

Waters 800 μ L 96-round well collection plate



SEE THIS CONSUMABLE
ON OUR E-SHOP

Manufacturer:
Waters

Part number:
186002481



1-channel pipettes					
10 μ L	120 μ L	300 μ L	1000 μ L	5mL	10mL
✓	✓	✓	50	200	400

8-channel pipettes			
10 μ L	120 μ L	300 μ L	1200 μ L
200	✓	✓	✓



MICROPLATE SHAKER+
Direct Compatibility
PN: 176004577

Waters QuanRecovery™ 700 µL 96-well plate



SEE THIS CONSUMABLE
ON OUR E-SHOP

Manufacturer:
Waters

Part number:
186009185



1-channel pipettes					
10µL	120µL	300µL	1000µL	5mL	10mL
✓	✓	✓	50	200	400

8-channel pipettes			
10µL	120µL	300µL	1200µL
200	✓	✓	✓



MICROPLATE SHAKER+
Direct Compatibility
PN: 176004577

WebSeal 0.5 mL 96-well V-bottom plate



Manufacturer:
Thermo Scientific

Part number:
60180-P100



1-channel pipettes					
10 μ L	120 μ L	300 μ L	1000 μ L	5mL	10mL
✓	✓	✓	✓	⚠	⚠

8-channel pipettes			
10 μ L	120 μ L	300 μ L	1200 μ L
✓	✓	✓	✓



MICROPLATE SHAKER+
Direct Compatibility
PN: 176004577

WebSeal 2 mL 96-deep well U-bottom plate



Manufacturer:
Thermo Scientific

Part number:
60180-P104



1-channel pipettes					
10 μ L	120 μ L	300 μ L	1000 μ L	5mL	10mL
✓	✓	✓	✓	1 000	1 000

8-channel pipettes			
10 μ L	120 μ L	300 μ L	1200 μ L
✓	✓	✓	✓



MICROPLATE SHAKER+
Direct Compatibility
PN: 176004577

Ordering product number

176004577

OneLab reference: [518.4000]

MICROPLATE SHAKER+

EQUIPPED WITH 0.2ML MICROTUBE RACK (requires 186010303)

24X



Ordering product number

186010534



0.2mL Microtube Rack Domino

OneLab reference: [218.5071]



IMPORTANT

Compatibility of the 0.2mL Microtube Rack with the Microplate Shaker+ Device requires the purchase of the 0.2mL Microtube Rack Domino bundle (186010303).

Thermo Scientific™ 0.2 mL PCR microtube, racked



Manufacturer:
Thermo Scientific

Part number:
AB0620

1-channel pipettes					
10µL	120µL	300µL	1000µL	5mL	10mL
✓	✓	✓	50	🧪	🧪

8-channel pipettes			
10µL	120µL	300µL	1200µL
✗	✗	✗	✗

IMPORTANT

Compatibility of the Thermo Scientific™ 0.2mL PCR microtubes with the Shaker+ device requires the purchase of the 0.2mL Microtube Rack Domino Bundle (186010303)



Ordering product number
186010303



0.2mL Microtube Rack
Domino Bundle



MICROPLATE SHAKER+
Equipped with
0.2mL Microtube Rack
PN: 176004577
+ 186010534

Ordering product number

176004577

OneLab reference: [518.4000]

MICROPLATE SHAKER+

EQUIPPED WITH Ø12MM VIAL COLLECTION RACK



Ordering product number

186010531

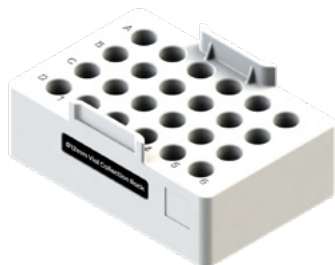

Ø12mm Vial Collection Rack

OneLab reference: [519.2601]



IMPORTANT

The Ø12mm Vial Collection Rack (24-position rack) is manufactured by Waters Corporation and specifically designed for use with the **Extraction+** connected device.

The Ø12mm Vial Collection Rack is sold separately from the Microplate Shaker+. A Collection Labware Rack Domino is only required for this rack when an automated movement to/from the Shaker+ (using the plate gripper tool) is required.

Waters 2 mL 12x32 mm LC/GC screw-top vial, racked



SEE THIS CONSUMABLE
ON OUR E-SHOP

Manufacturer:
Waters Corporation

Part number:
186000272C



1-channel pipettes					
10 μ L	120 μ L	300 μ L	1000 μ L	5mL	10mL
✓	✓	✓	1 000	⚠	⚠

8-channel pipettes			
10 μ L	120 μ L	300 μ L	1200 μ L
✗	✗	✗	✗



MICROPLATE SHAKER+
Compatibility via
Ø12mm Vial Collection Rack
PN: 186010523
+ 186010531

Waters 300 μ L 12x32mm screw neck vial, racked



SEE THIS CONSUMABLE
ON OUR E-SHOP

Manufacturer:
Waters Corporation

Part number:
186002639



1-channel pipettes					
10 μ L	120 μ L	300 μ L	1000 μ L	5mL	10mL
✓	✓	✓	150	🚫	🚫

8-channel pipettes			
10 μ L	120 μ L	300 μ L	1200 μ L
✗	✗	✗	✗



MICROPLATE SHAKER+
Compatibility via
Ø12mm Vial Collection Rack
PN: 186010523
+ 186010531

Waters 700 μL 12x32mm screw neck vial, racked



SEE THIS CONSUMABLE
ON OUR E-SHOP

Manufacturer:
Waters Corporation

Part number:
186005221



1-channel pipettes					
10 μL	120 μL	300 μL	1000 μL	5mL	10mL
✓	✓	✓	500	🚫	🚫

8-channel pipettes			
10 μL	120 μL	300 μL	1200 μL
✗	✗	✗	✗



MICROPLATE SHAKER+
Compatibility via
Ø12mm Vial Collection Rack
PN: 186010523
+ 186010531

Waters QuanRecovery™ 300 µL 12x32mm screw neck vial, racked



SEE THIS CONSUMABLE
ON OUR E-SHOP

Manufacturer:
Waters Corporation

Part number:
186009186



1-channel pipettes					
10µL	120µL	300µL	1000µL	5mL	10mL
✓	✓	✓	150	🚫	🚫

8-channel pipettes			
10µL	120µL	300µL	1200µL
✗	✗	✗	✗



MICROPLATE SHAKER+
Compatibility via
Ø12mm Vial Collection Rack
PN: 186010523
+ 186010531

Ordering product number

186010422

OneLab reference: [518.4100]

TUBE SHAKER+ W/ 12X75MM TUBE ADAPTOR



WITH

12x75mm Tube Adaptor OneLab reference: [518.3001]

The Tube Shaker+ is a OneLab connected device that uses market-leading orbital shaking technology to ensure vibration-free mixing speeds up to 2000rpm. Each Tube Shaker+ device is specifically designed to host dedicated tube types for maximum mixing efficiency.

**SEE THIS DEVICE
ON OUR E-SHOP**

Fisherbrand™ 6 mL round-bottom glass tube with plain end



Manufacturer:
Fisher Scientific

Part number:
14-961-26

1-channel pipettes					
10µL	120µL	300µL	1000µL	5mL	10mL
✓	✓	✓	✓	✓	✗

8-channel pipettes			
10µL	120µL	300µL	1200µL
✗	✗	✗	✗



**TUBE SHAKER+
W/ 12X75MM
TUBE ADAPTOR**
PN: 186010422

Ordering product number

176005077

OneLab reference: [518.4100]

TUBE SHAKER+ W/ 16X90MM TUBE ADAPTOR



WITH

16x90mm Tube Adaptor OneLab reference: [518.2501]

The Tube Shaker+ is a OneLab connected device that uses market-leading orbital shaking technology to ensure vibration-free mixing speeds up to 2000rpm. Each Tube Shaker+ device is specifically designed to host dedicated tube types for maximum mixing efficiency.

**SEE THIS DEVICE
ON OUR E-SHOP**

ACC, Pyrotube[®] 16x90mm depyrogenated glass tube



Manufacturer:

Associates of Cape
Cod, Inc.

Part number:

TB16C

1-channel pipettes

10 μ L	120 μ L	300 μ L	1000 μ L	5mL	10mL
✓	✓	✓	✓	✓	✓

8-channel pipettes

10 μ L	120 μ L	300 μ L	1200 μ L
✗	✗	✗	✗



**TUBE SHAKER+
W/ 16X90MM
TUBE ADAPTOR**
PN: 176005077

BRAND® AR-GLAS® 13 mL 16x100mm culture tube



Manufacturer:
BRAND

Part number:
114115

1-channel pipettes					
10µL	120µL	300µL	1000µL	5mL	10mL
5 000	2 500	2 500	✓	✓	✓

8-channel pipettes			
10µL	120µL	300µL	1200µL
✗	✗	✗	✗



**TUBE SHAKER+
W/ 16X90MM
TUBE ADAPTOR**
PN: 176005077

Charles River, 16x90mm endotoxin-free glass tube



Manufacturer:
Charles River

Part number:
TL700

1-channel pipettes					
10 μ L	120 μ L	300 μ L	1000 μ L	5mL	10mL
✓	✓	✓	✓	✓	✗

8-channel pipettes			
10 μ L	120 μ L	300 μ L	1200 μ L
✗	✗	✗	✗



**TUBE SHAKER+
W/ 16X90MM
TUBE ADAPTOR**
PN: 176005077

Ordering product number

176005078

OneLab reference: [518.4100]

TUBE SHAKER+ W/ 5ML TUBE ADAPTOR



WITH

5mL Tube Adaptor OneLab reference: [518.2601]

The Tube Shaker+ is a OneLab connected device that uses market-leading orbital shaking technology to ensure vibration-free mixing speeds up to 2000rpm. Each Tube Shaker+ device is specifically designed to host dedicated tube types for maximum mixing efficiency.

**SEE THIS DEVICE
ON OUR E-SHOP**

EndoGrade[®] 5 mL glass test tube



Manufacturer:
bioMérieux

Part number:
800050

1-channel pipettes					
10 μ L	120 μ L	300 μ L	1000 μ L	5mL	10mL
✓	✓	✓	✓	✓	✓

8-channel pipettes			
10 μ L	120 μ L	300 μ L	1200 μ L
✗	✗	✗	✗



TUBE SHAKER+
W/ 5ML TUBE ADAPTOR
PN: 176005078

Ordering product number

186010488

OneLab reference: [518.4100]

TUBE SHAKER+ WITH TILTED VIAL ADAPTOR



WITH

Tilted Vial Adaptor OneLab reference: [518.3221]

The Tube Shaker+ is a OneLab connected device that uses market-leading orbital shaking technology to ensure vibration-free mixing speeds up to 2000rpm. Each Tube Shaker+ device is specifically designed to host dedicated tube types for maximum mixing efficiency.

**E-SHOP AVAILABILITY
COMING SOON**

10 mL crimp-top glass vial



Manufacturer:
Associates of Cape
Cod, Inc.

Part number:
N/A

1-channel pipettes					
10 μ L	120 μ L	300 μ L	1000 μ L	5mL	10mL
✓	✓	✓	✓	⚠	⚠

8-channel pipettes			
10 μ L	120 μ L	300 μ L	1200 μ L
✗	✗	✗	✗



**TUBE SHAKER+ WITH
TILTED VIAL ADAPTOR**
PN: 186010488

Ordering product number

186010489

OneLab reference: [518.4300]

TUBE SHAKER+ W/40ML TUBE ADAPTOR



The Tube Shaker+ is a OneLab connected device that uses market-leading orbital shaking technology to ensure vibration-free mixing speeds up to 2000rpm. Each Tube Shaker+ device is specifically designed to host dedicated tube types for maximum mixing efficiency.

**E-SHOP AVAILABILITY
COMING SOON**

Pre-cleaned VOA 40mL vials, Open top



Manufacturer:
Shimadzu

Part number:
REST-21796

1-channel pipettes					
10 μ L	120 μ L	300 μ L	1000 μ L	5mL	10mL
✓	✓	✓	✓	✓	✓

8-channel pipettes			
10 μ L	120 μ L	300 μ L	1200 μ L
✗	✗	✗	✗



TUBE SHAKER+
W/40ML TUBE ADAPTOR
PN: 186010489

Ordering product number

176004852

OneLab reference: [518.4500]

MICROPLATE PELTIER+



The Microplate Peltier+ is a OneLab connected device that provides a compact all-in-one rapid heating and cooling solution for a growing variety of flat-bottom microplates. It can achieve and maintain temperatures ranging from 0-99°C.

**SEE THIS DEVICE
ON OUR E-SHOP**

CELLSTAR® 96-well clear F-bottom cell culture microplate

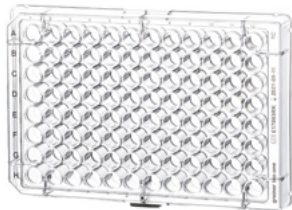

Manufacturer:
Greiner Bio-One

Part number:
655180



1-channel pipettes

10µL	120µL	300µL	1000µL	5mL	10mL
✓	✓	✓	✓	⚠	⚠

8-channel pipettes

10µL	120µL	300µL	1200µL
✓	✓	✓	✓

MICROPLATE PELTIER+
PN: 176004852

Greiner, 96-well PS F-bottom clear microplate



Manufacturer:
Greiner Bio-One

Part number:
655101



1-channel pipettes

10 μ L	120 μ L	300 μ L	1000 μ L	5mL	10mL
✓	✓	✓	✓	⚠	⚠

8-channel pipettes

10 μ L	120 μ L	300 μ L	1200 μ L
✓	✓	✓	✓



MICROPLATE PELTIER+
PN: 176004852

KingFisher™ 200uL Systems Consumable



Manufacturer:
Thermo Scientific

Part number:
97002084

1-channel pipettes					
10µL	120µL	300µL	1000µL	5mL	10mL
✓	✓	✓	✓	⚠	⚠

8-channel pipettes			
10µL	120µL	300µL	1200µL
✓	✓	✓	✓



MICROPLATE PELTIER+
PN: 176004852

Thermo Scientific™ 0.3 mL 96-well U-bottom MaxiSorp Immuno plate



Manufacturer:
Thermo Scientific

Part number:
449824

1-channel pipettes					
10 μ L	120 μ L	300 μ L	1000 μ L	5mL	10mL
✓	✓	✓	✓	✓	✓

8-channel pipettes			
10 μ L	120 μ L	300 μ L	1200 μ L
✓	✓	✓	✓



MICROPLATE PELTIER+
PN: 176004852

Thermo Scientific™ 400 µL Immuno Standard black 16-well strips in 96x plate



Manufacturer:
Thermo Scientific

Part number:
475515

1-channel pipettes					
10µL	120µL	300µL	1000µL	5mL	10mL
✓	✓	✓	✓	⚠	⚠

8-channel pipettes			
10µL	120µL	300µL	1200µL
✓	✓	✓	✓



MICROPLATE PELTIER+
PN: 176004852

TPP 12-well tissue culture test plate

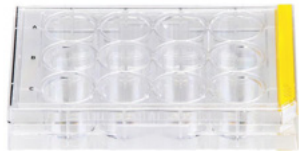

Manufacturer:
TPP AG

Part number:
92412



1-channel pipettes					
10 μ L	120 μ L	300 μ L	1000 μ L	5mL	10mL
✓	✓	✓	✓	✓	✓

8-channel pipettes			
10 μ L	120 μ L	300 μ L	1200 μ L
✗	✗	✗	✗



MICROPLATE PELTIER+
PN: 176004852

Ordering product number

176004584

OneLab reference: [518.4600]

96-PCR PELTIER+



The 96-PCR Peltier+ is a OneLab connected device that provides a compact all-in-one rapid heating and cooling solution for a growing variety of PCR-type microplates. It can quickly achieve and maintain temperatures ranging from 0-99°C.

**SEE THIS DEVICE
ON OUR E-SHOP**

Axygen® 96-well PCR white microplate



Manufacturer:
Starlab

Part number:
PCR-96-LC480-W-NF

1-channel pipettes					
10µL	120µL	300µL	1000µL	5mL	10mL
✓	✓	✓	✓	40	60

8-channel pipettes			
10µL	120µL	300µL	1200µL
✓	✓	✓	✓



96-PCR PELTIER+
PN: 176004584

Eppendorf twin.tec[®] 96-well skirted LoBind[®] PCR plate



Manufacturer:
Eppendorf

Part number:
0030129555



1-channel pipettes

10 μ L	120 μ L	300 μ L	1000 μ L	5mL	10mL
✓	✓	✓	✓	⚠	⚠

8-channel pipettes

10 μ L	120 μ L	300 μ L	1200 μ L
✗	✗	✗	✗



96-PCR PELTIER+
PN: 176004584

FrameStar® 0.1 mL 96-well skirted low profile PCR plate, clear wells



96-PCR PELTIER+
PN: 176004584

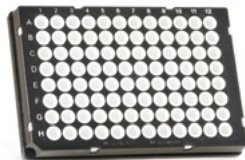

Manufacturer:
Azenta Life Sciences

Part number:
4ti-0960/RIG



1-channel pipettes

10µL	120µL	300µL	1000µL	5mL	10mL
✓	✓	✓	✓	🚫	🚫

8-channel pipettes

10µL	120µL	300µL	1200µL
✗	✗	✗	✗

FrameStar® break-a-way PCR plate in 96x FrameStrip® adapter

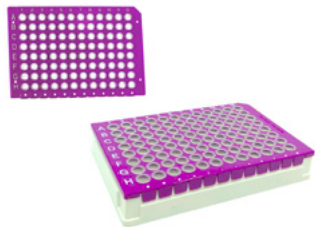

Manufacturer:
Azenta Life Sciences

Part number:
4ti-1000/P

1-channel pipettes					
10µL	120µL	300µL	1000µL	5mL	10mL
✓	✓	✓	✓	⚠	⚠

8-channel pipettes			
10µL	120µL	300µL	1200µL
✗	✗	✗	✗



96-PCR PELTIER+
PN: 176004584

FrameStrip® 8-well PCR tube strip in 96x FrameStrip® adapter

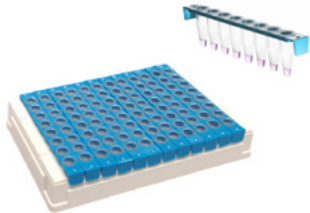

Manufacturer:
Azenta Life Sciences

Part number:
4ti-0786/B

1-channel pipettes					
10µL	120µL	300µL	1000µL	5mL	10mL
✓	✓	✓	✓	⚠	⚠

8-channel pipettes			
10µL	120µL	300µL	1200µL
✗	✗	✗	✗



96-PCR PELTIER+
PN: 176004584

Hard-Shell[®] 96-well low-profile skirted PCR plate, white/clear



Manufacturer:
Bio-Rad

Part number:
HSP9601



1-channel pipettes					
10 μ L	120 μ L	300 μ L	1000 μ L	5mL	10mL
✓	✓	✓	✓	⚠	⚠

8-channel pipettes			
10 μ L	120 μ L	300 μ L	1200 μ L
✗	✗	✗	✗



96-PCR PELTIER+
PN: 176004584

HardShell 96-well low-profile skirted PCR plate, blue/clear



Manufacturer:
PerkinElmer, Inc.

Part number:
6008870



1-channel pipettes					
10 μ L	120 μ L	300 μ L	1000 μ L	5mL	10mL
✓	✓	✓	✓	⚠	⚠

8-channel pipettes			
10 μ L	120 μ L	300 μ L	1200 μ L
✗	✗	✗	✗



96-PCR PELTIER+
PN: 176004584

MicroAmp™ 0.3 mL optical 96-well semi-skirted reaction plate



Manufacturer:
Applied Biosystems

Part number:
N8010560

1-channel pipettes					
10µL	120µL	300µL	1000µL	5mL	10mL
✓	✓	✓	100	🚫	🚫

8-channel pipettes			
10µL	120µL	300µL	1200µL
✗	✗	✗	✗



96-PCR PELTIER+
PN: 176004584

TempAssure® 0.2 mL 8-tube strip in Vari-Plate™ 96x frame



Manufacturer:
USA Scientific, Inc.

Part number:
1402-2500

1-channel pipettes					
10µL	120µL	300µL	1000µL	5mL	10mL
✓	✓	✓	100	⚠	⚠

8-channel pipettes			
10µL	120µL	300µL	1200µL
✓	✓	✓	✓



96-PCR PELTIER+
PN: 176004584

Thermo Scientific™ 96-well non-skirted PCR plate



Manufacturer:
Thermo Scientific

Part number:
AB0600

1-channel pipettes					
10µL	120µL	300µL	1000µL	5mL	10mL
✓	✓	✓	✓	⚠	⚠

8-channel pipettes			
10µL	120µL	300µL	1200µL
✓	✓	✓	✓



96-PCR PELTIER+
PN: 176004584

Ordering product number

176004850

OneLab reference: [518.5600]

96-PCR MAGNET+



The 96-PCR Magnet+ is a OneLab connected device that provides a simple and reliable way of fully automating the purification of genomic, plasmid and mitochondrial DNA using magnetic beads in small-volume plates. An automated moving shelf strategically positions magnets close to the bottom sides of consumables to optimize bead pelleting. The Andrew+ robot automatically and intelligently positions pipettes during pipetting steps with the Magnet+ so as to optimize purification workflows by not only avoiding the disturbance of pellets during pelleting phases, but also ensuring vigorous resuspension when necessary.

**SEE THIS DEVICE
ON OUR E-SHOP**

Eppendorf twin.tec® 96-well skirted LoBind® PCR plate



Manufacturer:
Eppendorf

Part number:
0030129555



1-channel pipettes					
10µL	120µL	300µL	1000µL	5mL	10mL
✓	✓	✓	✓	⚠	⚠

8-channel pipettes			
10µL	120µL	300µL	1200µL
✓	✓	✓	✓



96-PCR MAGNET+
PN: 176004850

FrameStar® 0.1 mL 96-well skirted low profile PCR plate, clear wells



96-PCR MAGNET+
PN: 176004850

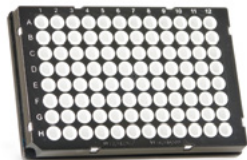

Manufacturer:
Azenta Life Sciences

Part number:
4ti-0960/RIG



1-channel pipettes

10µL	120µL	300µL	1000µL	5mL	10mL
✓	✓	✓	✓	⚠	⚠

8-channel pipettes

10µL	120µL	300µL	1200µL
✓	✓	✓	✓

Hard-Shell[®] 96-well low-profile skirted PCR plate, white/clear



Manufacturer:
Bio-Rad

Part number:
HSP9601



1-channel pipettes					
10 μ L	120 μ L	300 μ L	1000 μ L	5mL	10mL
✓	✓	✓	✓	⚠	⚠

8-channel pipettes			
10 μ L	120 μ L	300 μ L	1200 μ L
✓	✓	✓	✓



96-PCR MAGNET+
PN: 176004850

Ordering product number

176004854

OneLab reference: [518.5700]

DEEPWELL MAGNET+



The Deepwell Magnet+ is a OneLab connected device that provides a simple and reliable way of fully automating the purification of genomic, plasmid and mitochondrial DNA using magnetic beads in deepwell plates. An automated moving shelf strategically positions magnets close to the bottom sides of consumables to optimize bead pelleting. In parallel, the Andrew+ robot automatically and intelligently positions pipettes during pipetting steps with the Magnet+ so as to optimize purification workflows by not only avoiding the disturbance of pellets during pelleting phases, but also ensuring vigorous resuspension when necessary.

[SEE THIS DEVICE
ON OUR E-SHOP](#)

Abgene™ 0.8 mL 96-deep well storage plate

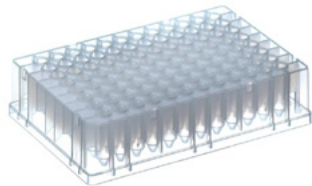

Manufacturer:
Thermo Scientific

Part number:
AB0859



1-channel pipettes					
10µL	120µL	300µL	1000µL	5mL	10mL
✓	✓	✓	50	200	400

8-channel pipettes			
10µL	120µL	300µL	1200µL
200	✓	✓	✓



DEEPWELL MAGNET+
PN: 176004854

Axygen® 1.1 mL 96-round deep well U-bottom plate



Manufacturer:
Corning Inc.

Part number:
P-DW-11-C



1-channel pipettes					
10µL	120µL	300µL	1000µL	5mL	10mL
✓	✓	✓	✓	✓	✓

8-channel pipettes			
10µL	120µL	300µL	1200µL
300	✓	✓	✓



DEEPWELL MAGNET+
PN: 176004854

Corning® 2 mL 96-square deep well V-bottom plate



Manufacturer:
Corning Inc.

Part number:
3960



1-channel pipettes					
10µL	120µL	300µL	1000µL	5mL	10mL
✓	✓	✓	✓	700	

8-channel pipettes			
10µL	120µL	300µL	1200µL
800	✓	✓	✓



DEEPWELL MAGNET+
PN: 176004854

Eppendorf 2 mL 96-deep well protein LoBind® plate, white frame



Manufacturer:
Eppendorf

Part number:
0030504305



1-channel pipettes					
10µL	120µL	300µL	1000µL	5mL	10mL
✓	✓	✓	✓	700	1 300

8-channel pipettes			
10µL	120µL	300µL	1200µL
900	✓	✓	✓



DEEPWELL MAGNET+
PN: 176004854

Eppendorf 2 mL 96-square deep well plate, yellow frame



Manufacturer:
Eppendorf

Part number:
0030501314



Compatible with
Microplate
Gripper

1-channel pipettes

10 μ L	120 μ L	300 μ L	1000 μ L	5mL	10mL
✓	✓	✓	✓	700	1 300

8-channel pipettes

10 μ L	120 μ L	300 μ L	1200 μ L
500	✓	✓	✓



DEEPWELL MAGNET+
PN: 176004854

KingFisher 96-deep well V-bottom plate



Manufacturer:
Thermo Scientific

Part number:
95040450



1-channel pipettes					
10 μ L	120 μ L	300 μ L	1000 μ L	5mL	10mL
✓	✓	✓	✓	700	1 300

8-channel pipettes			
10 μ L	120 μ L	300 μ L	1200 μ L
500	✓	✓	✓



DEEPWELL MAGNET+
PN: 176004854

Nunc™ 1.3 mL 96-DeepWell™ plate



Manufacturer:
Thermo Scientific

Part number:
260251



1-channel pipettes

10µL	120µL	300µL	1000µL	5mL	10mL
✓	✓	✓	✓	✓	✓

8-channel pipettes

10µL	120µL	300µL	1200µL
500	✓	✓	✓



DEEPWELL MAGNET+
PN: 176004854

Nunc™ 2 mL 96-DeepWell™ plate



Manufacturer:
Thermo Scientific

Part number:
278743



1-channel pipettes

10 μ L	120 μ L	300 μ L	1000 μ L	5mL	10mL
✓	✓	✓	✓	500	1 200

8-channel pipettes

10 μ L	120 μ L	300 μ L	1200 μ L
500	✓	✓	✓



DEEPWELL MAGNET+
PN: 176004854

Waters 700 μ L 96-round well collection plate



SEE THIS CONSUMABLE
ON OUR E-SHOP

Manufacturer:
Waters

Part number:
186005837



1-channel pipettes

10 μ L	120 μ L	300 μ L	1000 μ L	5mL	10mL
✓	✓	✓	100	100	

8-channel pipettes

10 μ L	120 μ L	300 μ L	1200 μ L
200	✓	✓	✓



DEEPWELL MAGNET+
PN: 176004854

Waters 800 μ L 96-round well collection plate



SEE THIS CONSUMABLE
ON OUR E-SHOP

Manufacturer:
Waters

Part number:
186002481



1-channel pipettes					
10 μ L	120 μ L	300 μ L	1000 μ L	5mL	10mL
✓	✓	✓	50	200	400

8-channel pipettes			
10 μ L	120 μ L	300 μ L	1200 μ L
200	✓	✓	✓



DEEPPWELL MAGNET+
PN: 176004854

Waters QuanRecovery™ 700 µL 96-well plate



**SEE THIS CONSUMABLE
ON OUR E-SHOP**

Manufacturer:
Waters

Part number:
186009185



1-channel pipettes					
10µL	120µL	300µL	1000µL	5mL	10mL
✓	✓	✓	50	200	400

8-channel pipettes			
10µL	120µL	300µL	1200µL
200	✓	✓	✓



DEEPWELL MAGNET+
PN: 176004854

Ordering product number

176004851

OneLab reference: [518.5500]

50ML TUBE MAGNET+



The 50mL Tube Magnet+ is a OneLab connected device that provides a simple and reliable way of fully automating the purification of genomic, plasmid and mitochondrial DNA using magnetic beads in mid-size tubes. An automated moving shelf automatically and strategically moves magnets across a wide surface of the tubes found within the device in order to optimize bead pelleting performance. In parallel, the Andrew+ robot automatically and intelligently positions pipettes during pipetting steps with the Magnet+ so as to optimize purification workflows by not only avoiding the disturbance of pellets during pelleting phases, but also ensuring vigorous resuspension when necessary.

[SEE THIS DEVICE
ON OUR E-SHOP](#)

Corning® 50 mL conical centrifuge tube



Manufacturer:
Corning Inc.

Part number:
430290

1-channel pipettes					
10 μ L	120 μ L	300 μ L	1000 μ L	5mL	10mL
✓	✓	✓	✓	✓	✓

8-channel pipettes			
10 μ L	120 μ L	300 μ L	1200 μ L
✗	✗	✗	✗



50ML TUBE MAGNET+
PN: 176004851

Falcon® 50 mL conical centrifuge tube



Manufacturer:
Corning Inc.

Part number:
352070

1-channel pipettes					
10 μ L	120 μ L	300 μ L	1000 μ L	5mL	10mL
✓	✓	✓	✓	✓	✓

8-channel pipettes			
10 μ L	120 μ L	300 μ L	1200 μ L
✗	✗	✗	✗



50ML TUBE MAGNET+
PN: 176004851

Nunc™ 50 mL conical centrifuge tube



Manufacturer:
Thermo Scientific

Part number:
339652

1-channel pipettes					
10µL	120µL	300µL	1000µL	5mL	10mL
✓	✓	✓	✓	✓	✓

8-channel pipettes			
10µL	120µL	300µL	1200µL
✗	✗	✗	✗



50ML TUBE MAGNET+
PN: 176004851

VWR® 50 mL conical centrifuge tube



Manufacturer:
VWR International

Part number:
525-0610

1-channel pipettes					
10µL	120µL	300µL	1000µL	5mL	10mL
✓	✓	✓	✓	✓	✓

8-channel pipettes			
10µL	120µL	300µL	1200µL
✗	✗	✗	✗



50ML TUBE MAGNET+
PN: 176004851

Ordering product number

VARIABLE

OneLab reference: [518.4200]

HEATER-SHAKER+

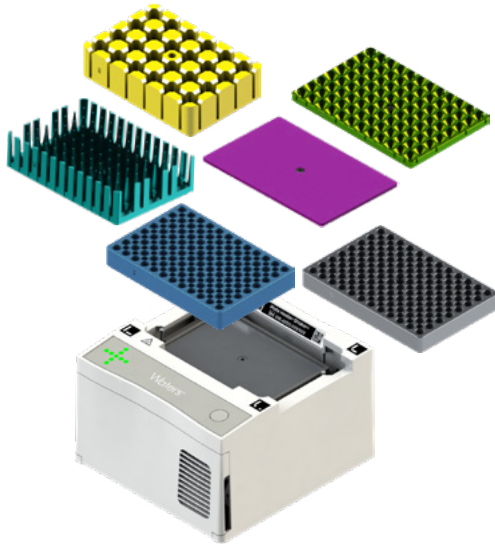

The Heater-Shaker+ device provides high-speed mixing & temperature control for the most demanding applications. This uniquely designed compact device is suitable for a wide range of labware thanks to its interchangeable adaptors. It combines both heating (from ambient to 99 °C) and vibration-free shaking (from 200 up to 2,500 rpm). Maximum recommended shaking speeds depend on the adaptor that the device is equipped with.

Ordering product number

176005079

OneLab reference: [518.4200]

HEATER-SHAKER+ W/ LOW-PROFILE PLATE ADAPTER

EQUIPPED WITH LOW-PROFILE PLATE ADAPTOR

96X

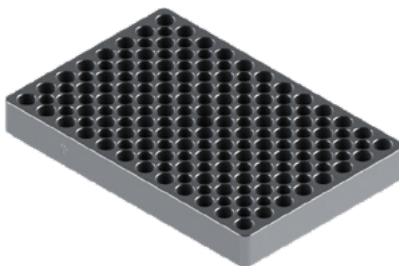

Low-Profile 96-PCR Plate Adaptor,
Engraved Marking Code #B
OneLab reference: [518.2701]

SEE THIS DEVICE
ON OUR E-SHOP

Eppendorf twin.tec® 96-well skirted LoBind® PCR plate



Manufacturer:

Eppendorf

Part number:

30129555



1-channel pipettes					
10µL	120µL	300µL	1000µL	5mL	10mL
✓	✓	✓	✓	✗	✗

8-channel pipettes			
10µL	120µL	300µL	1200µL
✓	✓	✓	✓



HEATER-SHAKER+
Equipped with
Low-Profile Plate Adaptor
PN: 176005079
+ 700013336

Ordering product number

176005080

OneLab reference: [518.4200]

HEATER-SHAKER+ W/ HIGH-PROFILE PLATE ADAPTER

EQUIPPED WITH HIGH-PROFILE PLATE ADAPTOR

96X

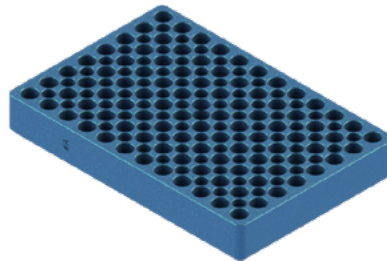

High-Profile 96-PCR Plate Adaptor,
Engraved Marking Code #A
OneLab reference: [518.2801]

SEE THIS DEVICE
ON OUR E-SHOP

FrameStar® break-a-way PCR plate in 96x FrameStrip® adapter

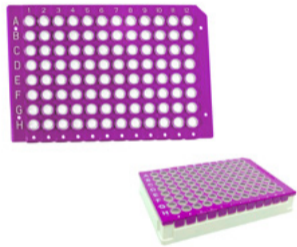

Manufacturer:
Azenta Life Sciences

Part number:
4ti-1000/P

1-channel pipettes					
10 μ L	120 μ L	300 μ L	1000 μ L	5mL	10mL
✓	✓	✓	✓	✗	✗

8-channel pipettes			
10 μ L	120 μ L	300 μ L	1200 μ L
✓	✓	✓	✓



HEATER-SHAKER+
Equipped with
High-Profile Plate Adaptor
PN: 176005080
+ 700013336

FrameStrip® 8-well PCR tube strip in 96x FrameStrip® adapter

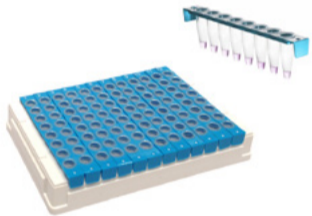

Manufacturer:
Azenta Life Sciences

Part number:
4ti-0786/B

1-channel pipettes					
10µL	120µL	300µL	1000µL	5mL	10mL
✓	✓	✓	✓	✗	✗

8-channel pipettes			
10µL	120µL	300µL	1200µL
✓	✓	✓	✓



HEATER-SHAKER+
Equipped with
High-Profile Plate Adaptor
PN: 176005080
+ 700013336

Ordering product number

186010426

OneLab reference: [518.4200]

HEATER-SHAKER+ W/ DEEPWELL PLATE ADAPTOR

EQUIPPED WITH DEEPWELL PLATE ADAPTOR

96X



Ordering product number

186010425

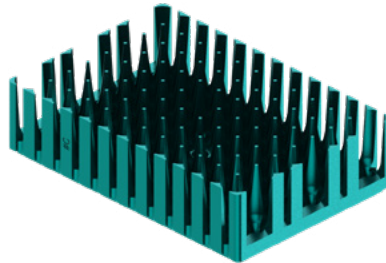

96-Deepwell Plate Adaptor,
Engraved Marking Code #C
OneLab reference: [518.3131]

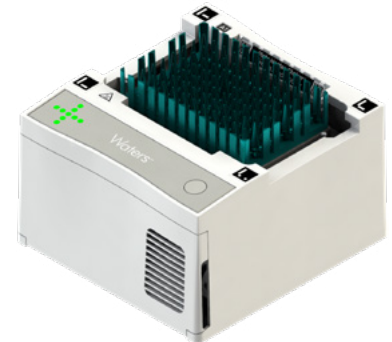

SEE THIS DEVICE
ON OUR E-SHOP

Abgene™ 0.8 mL 96-deep well storage plate

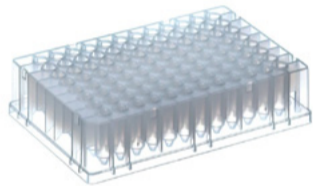

Manufacturer:
Thermo Scientific

Part number:
AB0859



1-channel pipettes					
10 μ L	120 μ L	300 μ L	1000 μ L	5mL	10mL
✓	✓	✓	50	200	400

8-channel pipettes			
10 μ L	120 μ L	300 μ L	1200 μ L
200	✓	✓	✓



HEATER-SHAKER+
Equipped with
Deepwell Plate Adaptor
PN: 186010426
+ 186010425

Eppendorf 0.5 mL 96-deep well protein LoBind® plate, yellow frame



Manufacturer:

Eppendorf

Part number:

0030504119



Compatible with
Microplate
Gripper

1-channel pipettes

10 μ L	120 μ L	300 μ L	1000 μ L	5mL	10mL
✓	✓	✓	✓	✓	300

8-channel pipettes

10 μ L	120 μ L	300 μ L	1200 μ L
300	✓	✓	✓



HEATER-SHAKER+
Equipped with
Deepwell Plate Adaptor
PN: 186010426
+ 186010425

Eppendorf 1 mL 96-deep well protein LoBind® plate, yellow frame



Manufacturer:

Eppendorf

Part number:

0030504216



Compatible with
Microplate
Gripper

1-channel pipettes

10 μ L	120 μ L	300 μ L	1000 μ L	5mL	10mL
✓	✓	✓	600	650	

8-channel pipettes

10 μ L	120 μ L	300 μ L	1200 μ L
500	✓	✓	✓



HEATER-SHAKER+
Equipped with
Deepwell Plate Adaptor
PN: 186010426
+ 186010425

Waters 800 μ L 96-round well collection plate



SEE THIS CONSUMABLE
ON OUR E-SHOP

Manufacturer:
Waters Corporation

Part number:
186002481



1-channel pipettes					
10 μ L	120 μ L	300 μ L	1000 μ L	5mL	10mL
✓	✓	✓	50	200	400

8-channel pipettes			
10 μ L	120 μ L	300 μ L	1200 μ L
200	✓	✓	✓



HEATER-SHAKER+
Equipped with
Deepwell Plate Adaptor
PN: 186010426
+ 186010425

Waters QuanRecovery™ 700 µL 96-well plate



SEE THIS CONSUMABLE
ON OUR E-SHOP

Manufacturer:
Waters Corporation

Part number:
186009185



1-channel pipettes					
10µL	120µL	300µL	1000µL	5mL	10mL
✓	✓	✓	50	200	400

8-channel pipettes			
10µL	120µL	300µL	1200µL
200	✓	✓	✓



HEATER-SHAKER+
Equipped with
Deepwell Plate Adaptor
PN: 186010426
+ 186010425

Ordering product number

186010495

OneLab reference: [518.4200]

HEATER-SHAKER+ W/ FLAT-BOTTOM PLATE ADAPTER

EQUIPPED WITH FLAT-BOTTOM PLATE ADAPTOR



Ordering product number
186010493

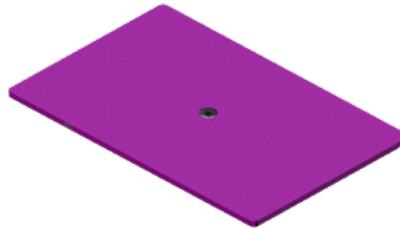

Flat-bottom Plate Adaptor,
Engraved Marking Code #D
OneLab reference: [518.3211]



**E-SHOP AVAILABILITY
COMING SOON**

24-well plate with glass bottom



Manufacturer:
Cellvis

Part number:
P24-1.5H-N

1-channel pipettes					
10 μ L	120 μ L	300 μ L	1000 μ L	5mL	10mL
✓	✓	✓	✓	✓	✓

8-channel pipettes			
10 μ L	120 μ L	300 μ L	1200 μ L
✗	✗	✗	✗



HEATER-SHAKER+
Equipped with
Flat-Bottom Plate Adaptor
PN: 186010495
+ 186010493

96-well plate with glass bottom



Manufacturer:

Cellvis

Part number:

P96-1.5H-N

1-channel pipettes

10 μ L	120 μ L	300 μ L	1000 μ L	5mL	10mL
✓	✓	✓	✓	✓	✗

8-channel pipettes

10 μ L	120 μ L	300 μ L	1200 μ L
✓	✓	✓	✓



HEATER-SHAKER+

Equipped with

Flat-Bottom Plate Adaptor

PN: 186010495

+ 186010493

ACC, Pyroclear[®] Pyroplate[®] 96-well microplate

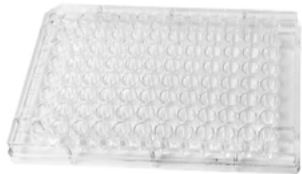

Manufacturer:
Associates of Cape
Cod, Inc.

Part number:
CA961-50



1-channel pipettes					
10 μ L	120 μ L	300 μ L	1000 μ L	5mL	10mL
✓	✓	✓	✓	✗	✗

8-channel pipettes			
10 μ L	120 μ L	300 μ L	1200 μ L
✓	✓	✓	✓



HEATER-SHAKER+
Equipped with
Flat-Bottom Plate Adaptor
PN: 186010495
+ 186010493

CELLSTAR® 96-well clear F-bottom cell culture microplate

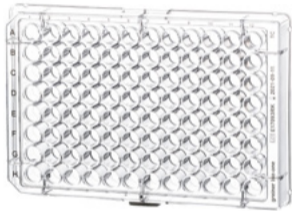

Manufacturer:
Greiner Bio-One

Part number:
655180



1-channel pipettes					
10µL	120µL	300µL	1000µL	5mL	10mL
✓	✓	✓	✓	✗	✗

8-channel pipettes			
10µL	120µL	300µL	1200µL
✓	✓	✓	✓



HEATER-SHAKER+
Equipped with
Flat-Bottom Plate Adaptor
PN: 186010495
+ 186010493

Corning® 96-well Half Area, Glass Bottom Microplate



Manufacturer:

Corning Inc.

Part number:

4580

1-channel pipettes					
10 μ L	120 μ L	300 μ L	1000 μ L	5mL	10mL
✓	✓	✓	✓	✗	✗

8-channel pipettes			
10 μ L	120 μ L	300 μ L	1200 μ L
✗	✗	✗	✗



HEATER-SHAKER+

Equipped with

Flat-Bottom Plate Adaptor

PN: 186010495

+ 186010493

Corning® 384-Well Clear Round Bottom Microplate

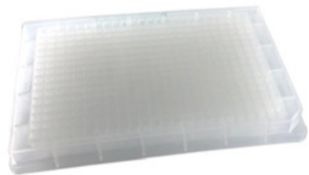

Manufacturer:

Corning Inc.

Part number:

3656



1-channel pipettes					
10 μ L	120 μ L	300 μ L	1000 μ L	5mL	10mL
✓	✓	✓	✓	✗	✗

8-channel pipettes			
10 μ L	120 μ L	300 μ L	1200 μ L
✓	✓	✓	✓



HEATER-SHAKER+

Equipped with

Flat-Bottom Plate Adaptor

PN: 186010495

+ 186010493

Greiner, 96-well PS F-bottom clear microplate



Manufacturer:
Greiner Bio-One

Part number:
655101



1-channel pipettes					
10 μ L	120 μ L	300 μ L	1000 μ L	5mL	10mL
✓	✓	✓	✓	✗	✗

8-channel pipettes			
10 μ L	120 μ L	300 μ L	1200 μ L
✓	✓	✓	✓



HEATER-SHAKER+
Equipped with
Flat-Bottom Plate Adaptor
PN: 186010495
+ 186010493

High Binding 96-Stripwell™ Flat Bottom Microplate

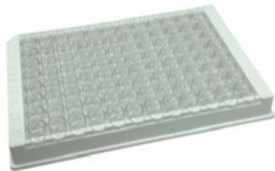

Manufacturer:

Corning Inc.

Part number:

7642

1-channel pipettes					
10 μ L	120 μ L	300 μ L	1000 μ L	5mL	10mL
✓	✓	✓	✓	✓	✗

8-channel pipettes			
10 μ L	120 μ L	300 μ L	1200 μ L
✓	✓	✓	✓



HEATER-SHAKER+

Equipped with

Flat-Bottom Plate Adaptor

PN: 186010495

+ 186010493

ibidi, 96-well ibiTreat black μ -Plate w/ polymer coverslip bottom



Manufacturer:
ibidi

Part number:
89626

1-channel pipettes					
10 μ L	120 μ L	300 μ L	1000 μ L	5mL	10mL
✓	✓	✓	✓	✓	✓

8-channel pipettes			
10 μ L	120 μ L	300 μ L	1200 μ L
✓	✓	✓	✓



HEATER-SHAKER+

Equipped with

Flat-Bottom Plate Adaptor

PN: 186010495

+ 186010493

Pierce™ 96-Well Polystyrene Plates with Corner Notch



Manufacturer:
Thermo Scientific

Part number:
15041

1-channel pipettes

10 μ L	120 μ L	300 μ L	1000 μ L	5mL	10mL
✓	✓	✓	✓	✓	✗

8-channel pipettes

10 μ L	120 μ L	300 μ L	1200 μ L
✓	✓	✓	✓



HEATER-SHAKER+
Equipped with
Flat-Bottom Plate Adaptor
PN: 186010495
+ 186010493

TPP 12-well tissue culture test plate

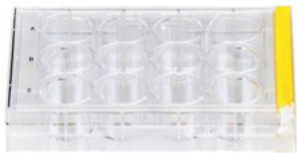

Manufacturer:
TPP AG

Part number:
92412

1-channel pipettes					
10 μ L	120 μ L	300 μ L	1000 μ L	5mL	10mL
✓	✓	✓	✓	✓	✓

8-channel pipettes			
10 μ L	120 μ L	300 μ L	1200 μ L
✗	✗	✗	✗



HEATER-SHAKER+
Equipped with
Flat-Bottom Plate Adaptor
PN: 186010495
+ 186010493

Ordering product number

186010496

OneLab reference: [518.4200]

HEATER-SHAKER+ W/ SOLID-BASE PLATE ADAPTER

EQUIPPED WITH SOLID-BASE PLATE ADAPTOR

96X



Ordering product number

186010492

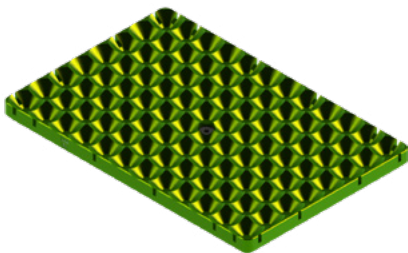

Solid-Base Plate Adaptor,
Engraved Marking Code #E
OneLab reference: [518.3311]



**E-SHOP AVAILABILITY
COMING SOON**

Agilent 96-well plate, 2.2 mL



Manufacturer:
Agilent Technologies

Part number:
5043-9300



1-channel pipettes					
10 μ L	120 μ L	300 μ L	1000 μ L	5mL	10mL
✓	✓	✓	✓	300	750

8-channel pipettes			
10 μ L	120 μ L	300 μ L	1200 μ L
300	✓	✓	✓



HEATER-SHAKER+
Equipped with
Solid-Base Plate Adaptor
PN: 186010496
+ 186010492

Eppendorf 2 mL 96-square deep well plate, yellow frame



Manufacturer:

Eppendorf

Part number:

0030501314



Compatible with
Microplate
Gripper

1-channel pipettes

10 μ L	120 μ L	300 μ L	1000 μ L	5mL	10mL
✓	✓	✓	✓	700	1 300

8-channel pipettes

10 μ L	120 μ L	300 μ L	1200 μ L
500	✓	✓	✓



HEATER-SHAKER+
Equipped with
Solid-Base Plate Adaptor
PN: 186010496
+ 186010492

Matrix™ 0.75 mL blank storage tube in 96x rack



Manufacturer:
Thermo Scientific

Part number:
4272

1-channel pipettes					
10µL	120µL	300µL	1000µL	5mL	10mL
✓	✓	✓	300	⚠	⚠

8-channel pipettes			
10µL	120µL	300µL	1200µL
200	✓	✓	✓



HEATER-SHAKER+
Equipped with
Solid-Base Plate Adaptor
PN: 186010496
+ 186010492

Ordering product number

186010494

OneLab reference: [518.4200]

HEATER-SHAKER+ W/ CRYOVIAL ADAPTER

EQUIPPED WITH CRYOVIALS ADAPTOR



Ordering product number
186010491

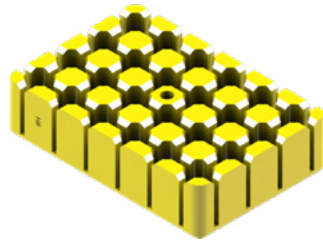

Cryovials Adaptor,
Engraved Marking Code #E
OneLab reference: [518.3411]



**E-SHOP AVAILABILITY
COMING SOON**

2mL cryovial with Inner Thread, in 24 position rack



Manufacturer:
Biozym

Part number:
710522

1-channel pipettes					
10µL	120µL	300µL	1000µL	5mL	10mL
✓	✓	✓	✓	✓	✓

8-channel pipettes			
10µL	120µL	300µL	1200µL
✗	✗	✗	✗

IMPORTANT

The Heater-Shaker+ Device with Cryovials Adaptor requires the use of the Cryovial Collection Rack (186011194) for these vials to be compatible. The Cryovial Collection Rack can be purchased individually or as part of the bundle 176XXXXX



Ordering product number
186011194



CryoVial Collection Rack



Compatible with
Microplate
Gripper



HEATER-SHAKER+
Equipped with
Cryovials Adaptor
PN: 186010494
+ 186010491

Ordering product number
176005201/-202
OneLab reference: [518.7000]

EXTRACTION+

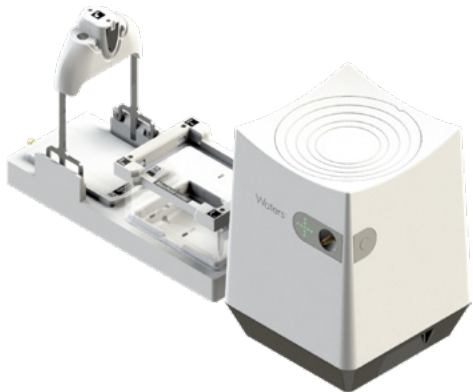

The Extraction+ system comprises the manifold with the collar lifter and the connected vacuum pump.

EXTRACTION+ SYSTEM W/ MICROPLATE GRIPPER

[SEE THIS DEVICE
ON OUR E-SHOP](#)

Ordering part number : 176005201

EXTRACTION+ SYSTEM W/O MICROPLATE GRIPPER

[SEE THIS DEVICE
ON OUR E-SHOP](#)

Ordering part number : 176005202

DIRECT COMPATIBILITY

No adaptors are required for the following Extraction labware to be compatible with the Extraction+ Device

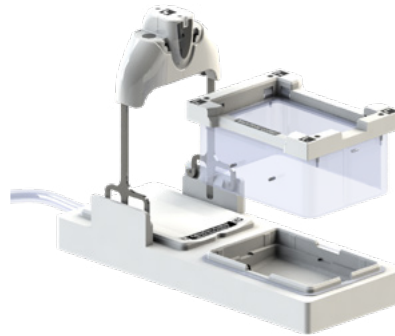

IMPORTANT

Multiple different formats of consumables are compatible with the Extraction+ Device. Look out for the following format symbols and ensure that they match between your extraction and collection labware before making a selection. The 1x format is compatible with all extraction labware formats, but only for waste collection and not as a sample collection option.



AcroPrep™ 7 mL 24-well Cell Clarification and Sterile Filtration plate



Manufacturer:
Pall Corporation

Part number:
97016

●●●●●●
24X
●●●●●●

1-channel pipettes

10 μ L	120 μ L	300 μ L	1000 μ L	5mL	10mL
✓	✓	✓	✓	✓	✓

8-channel pipettes

10 μ L	120 μ L	300 μ L	1200 μ L
✗	✗	✗	✗



**EXTRACTION +
EXTRACTION LABWARE**
Direct Compatibility
PN: 176005201/-202

Acroprep Advance 96-well Filter 2mL Plate



Manufacturer:
Pall Corporation

Part number:
8231

24X

1-channel pipettes

10 μ L	120 μ L	300 μ L	1000 μ L	5mL	10mL
✓	✓	✓	✓	600	1 000

8-channel pipettes

10 μ L	120 μ L	300 μ L	1200 μ L
700	✓	✓	✓



**EXTRACTION +
EXTRACTION LABWARE**
Direct Compatibility
PN: 176005201/-202

AcroPrep™ Advance 1 mL 96-well filter plate, 30K Omega membrane



Manufacturer:
Pall Corporation

Part number:
8165



1-channel pipettes					
10µL	120µL	300µL	1000µL	5mL	10mL
✓	✓	✓	✓	✓	✓

8-channel pipettes			
10µL	120µL	300µL	1200µL
✓	✓	✓	✓



**EXTRACTION +
EXTRACTION LABWARE**
Direct Compatibility
PN: 176005201/-202

AcroPrep™ Advance 350 μ L 96-well filter plate, 10K Omega membrane



Manufacturer:
Pall Corporation

Part number:
8034

96X

1-channel pipettes

10 μ L	120 μ L	300 μ L	1000 μ L	5mL	10mL
✓	✓	✓	✓	✓	✓

8-channel pipettes

10 μ L	120 μ L	300 μ L	1200 μ L
✓	✓	✓	✓



**EXTRACTION +
EXTRACTION LABWARE**
Direct Compatibility
PN: 176005201/-202

Advantage™ 2 mL 96-well diatomaceous earth filter plate



Manufacturer:
Analytical Sales
& Services, Inc.

Part number:
96260-1



1-channel pipettes					
10µL	120µL	300µL	1000µL	5mL	10mL
✓	✓	✓	✓	✓	✓

8-channel pipettes			
10µL	120µL	300µL	1200µL
✓	✓	✓	✓



**EXTRACTION +
EXTRACTION LABWARE**
Direct Compatibility
PN: 176005201/-202

ArcticWhite, 400 μ L 96-well filter plate, hydrophilic PVDF, 0.45 μ m



Manufacturer:
ArcticWhite LLC

Part number:
AWFP-F20011

96X

1-channel pipettes					
10 μ L	120 μ L	300 μ L	1000 μ L	5mL	10mL
✓	✓	✓	✓	⚠	⚠

8-channel pipettes			
10 μ L	120 μ L	300 μ L	1200 μ L
✓	✓	✓	✓



**EXTRACTION +
EXTRACTION LABWARE**
Direct Compatibility
PN: 1760052011-202

Biotage ISOLUTE® SLE+ 200 µL 96-well SLE plate



Manufacturer:
Biotage

Part number:
820-0200-P01

96X

1-channel pipettes					
10µL	120µL	300µL	1000µL	5mL	10mL
✓	✓	✓	✓	✓	700

8-channel pipettes			
10µL	120µL	300µL	1200µL
✓	✓	✓	✓



**EXTRACTION +
EXTRACTION LABWARE**
Direct Compatibility
PN: 176005201/-202

Cytiva, PreDictor 96-well plate, 150 μ L MabSelect resin/well



Manufacturer:
Cytiva

Part number:
28985262



1-channel pipettes					
10 μ L	120 μ L	300 μ L	1000 μ L	5mL	10mL
✓	✓	✓	150	200	🚫

8-channel pipettes			
10 μ L	120 μ L	300 μ L	1200 μ L
✓	✓	✓	✓



**EXTRACTION +
EXTRACTION LABWARE**
Direct Compatibility
PN: 176005201/-202

MACHEREY-NAGEL, NucleoSpin[®] 96 virus binding plate



Manufacturer:
MACHEREY-NAGEL

Part number:
740691.4S

96X

1-channel pipettes					
10µL	120µL	300µL	1000µL	5mL	10mL
✓	✓	✓	✓	✓	✗

8-channel pipettes			
10µL	120µL	300µL	1200µL
✓	✓	✓	✓



**EXTRACTION +
EXTRACTION LABWARE**
Direct Compatibility
PN: 176005201/-202

MultiScreen® HTS HV clear 96-well filter plate, 0.45 µm pore size



Manufacturer:
Merck

Part number:
MSHVS4510

96X

1-channel pipettes					
10µL	120µL	300µL	1000µL	5mL	10mL
✓	✓	✓	✓	⚠	⚠

8-channel pipettes			
10µL	120µL	300µL	1200µL
✓	✓	✓	✓

**EXTRACTION +
EXTRACTION LABWARE**
Direct Compatibility
PN: 176005201/-202

MultiScreen® Solvinert™ 96-well filter plate, 0.45 µm pore size



Manufacturer:
Merck

Part number:
MSRLN0450

96X

1-channel pipettes					
10µL	120µL	300µL	1000µL	5mL	10mL
✓	✓	✓	✓	⚠	⚠

8-channel pipettes			
10µL	120µL	300µL	1200µL
✓	✓	✓	✓



**EXTRACTION +
EXTRACTION LABWARE**
Direct Compatibility
PN: 176005201/-202

Oasis HLB 96-square well plate, 30 mg sorbent/well



SEE THIS CONSUMABLE
ON OUR E-SHOP

Manufacturer:
Waters Corporation

Part number:
WAT058951

96X

1-channel pipettes					
10 μ L	120 μ L	300 μ L	1000 μ L	5mL	10mL
✓	✓	✓	✓	⚠	⚠

8-channel pipettes			
10 μ L	120 μ L	300 μ L	1200 μ L
✓	✓	✓	✓



**EXTRACTION +
EXTRACTION LABWARE**
Direct Compatibility
PN: 176005201/-202

Oasis HLB 96-square well plate, 60 mg sorbent/well



SEE THIS CONSUMABLE
ON OUR E-SHOP

Manufacturer:
Waters

Part number:
186000679

96X

1-channel pipettes					
10 μ L	120 μ L	300 μ L	1000 μ L	5mL	10mL
✓	✓	✓	✓	⚠	⚠

8-channel pipettes			
10 μ L	120 μ L	300 μ L	1200 μ L
✓	✓	✓	✓



EXTRACTION +
EXTRACTION LABWARE
Direct Compatibility
PN: 176005201/-202

Oasis HLB 96-well μ Elution plate, 2 mg sorbent/well



SEE THIS CONSUMABLE
ON OUR E-SHOP

Manufacturer:
Waters

Part number:
186001828BA

96X

1-channel pipettes					
10 μ L	120 μ L	300 μ L	1000 μ L	5mL	10mL
✓	✓	✓	✓	⚠	⚠

8-channel pipettes			
10 μ L	120 μ L	300 μ L	1200 μ L
✓	✓	✓	✓



EXTRACTION +
EXTRACTION LABWARE
Direct Compatibility
PN: 176005201/-202

Oasis method development 96-well μ Elution plate, 2 mg sorbent/well



SEE THIS CONSUMABLE
ON OUR E-SHOP

Manufacturer:
Waters

Part number:
186004475

96X

1-channel pipettes

10 μ L	120 μ L	300 μ L	1000 μ L	5mL	10mL
✓	✓	✓	✓	✓	⚠

8-channel pipettes

10 μ L	120 μ L	300 μ L	1200 μ L
✓	✓	✓	✓



EXTRACTION +
EXTRACTION LABWARE
Direct Compatibility
PN: 176005201/-202

Oasis peptide method development 96-well μ Elution plate, 2 mg sorbent/well



SEE THIS CONSUMABLE
ON OUR E-SHOP

Manufacturer:
Waters Corporation

Part number:
186004713

96X

1-channel pipettes

10 μ L	120 μ L	300 μ L	1000 μ L	5mL	10mL
✓	✓	✓	✓	150	200

8-channel pipettes

10 μ L	120 μ L	300 μ L	1200 μ L
✓	✓	✓	✓



**EXTRACTION +
EXTRACTION LABWARE**
Direct Compatibility
PN: 176005201/-202

Oasis PRiME HLB 96-well plate, 10 mg sorbent/well



SEE THIS CONSUMABLE
ON OUR E-SHOP

Manufacturer:
Waters Corporation

Part number:
186008053

96X

1-channel pipettes					
10 μ L	120 μ L	300 μ L	1000 μ L	5mL	10mL
✓	✓	✓	✓	⚠	⚠

8-channel pipettes			
10 μ L	120 μ L	300 μ L	1200 μ L
✓	✓	✓	✓



EXTRACTION +
EXTRACTION LABWARE
Direct Compatibility
PN: 176005201/-202

Oasis PRiME HLB 96-well plate, 30 mg sorbent/well



SEE THIS CONSUMABLE
ON OUR E-SHOP

Manufacturer:
Waters Corporation

Part number:
186008054

96X

1-channel pipettes					
10 μ L	120 μ L	300 μ L	1000 μ L	5mL	10mL
✓	✓	✓	✓	✓	⚠

8-channel pipettes			
10 μ L	120 μ L	300 μ L	1200 μ L
✓	✓	✓	✓



EXTRACTION +
EXTRACTION LABWARE
Direct Compatibility
PN: 176005201/-202

Oasis PRiME HLB 96-well μ Elution plate, 3 mg sorbent/well



SEE THIS CONSUMABLE
ON OUR E-SHOP

Manufacturer:
Waters

Part number:
186008052

96X

1-channel pipettes					
10 μ L	120 μ L	300 μ L	1000 μ L	5mL	10mL
✓	✓	✓	✓	✓	⚠

8-channel pipettes			
10 μ L	120 μ L	300 μ L	1200 μ L
✓	✓	✓	✓



**EXTRACTION +
EXTRACTION LABWARE**
Direct Compatibility
PN: 176005201/-202

Oasis PRiME MCX 96-well μ Elution plate, 2 mg sorbent/well



SEE THIS CONSUMABLE
ON OUR E-SHOP

Manufacturer:
Waters

Part number:
186008914

96X

1-channel pipettes					
10 μ L	120 μ L	300 μ L	1000 μ L	5mL	10mL
✓	✓	✓	✓	✓	⚠

8-channel pipettes			
10 μ L	120 μ L	300 μ L	1200 μ L
✓	✓	✓	✓



EXTRACTION +
EXTRACTION LABWARE
Direct Compatibility
PN: 176005201/-202

Ostro protein precipitation & phospholipid removal 96-well plate



SEE THIS CONSUMABLE
ON OUR E-SHOP

Manufacturer:
Waters

Part number:
186005518

96X

1-channel pipettes					
10 μ L	120 μ L	300 μ L	1000 μ L	5mL	10mL
✓	✓	✓	✓	⚠	⚠

8-channel pipettes			
10 μ L	120 μ L	300 μ L	1200 μ L
✓	✓	✓	✓



EXTRACTION +
EXTRACTION LABWARE
Direct Compatibility
PN: 176005201/-202

PreDictor MabSelect SuRe, 50 μ L 96-Well Plate



Manufacturer:
Cytiva

Part number:
28925825



1-channel pipettes					
10 μ L	120 μ L	300 μ L	1000 μ L	5mL	10mL
✓	✓	✓	300	300	

8-channel pipettes			
10 μ L	120 μ L	300 μ L	1200 μ L
✓	✓	✓	✓



**EXTRACTION +
EXTRACTION LABWARE**
Direct Compatibility
PN: 176005201/-202

Thermo Scientific™ HyperSep™ 96-well PPT plate



Manufacturer:
Thermo Scientific

Part number:
60304-201

96X

1-channel pipettes					
10 μ L	120 μ L	300 μ L	1000 μ L	5mL	10mL
✓	✓	✓	✓	✓	✓

8-channel pipettes			
10 μ L	120 μ L	300 μ L	1200 μ L
✓	✓	✓	✓



**EXTRACTION +
EXTRACTION LABWARE**
Direct Compatibility
PN: 176005201/-202

Waters GlycoWorks™ HILIC μ Elution plate



SEE THIS CONSUMABLE
ON OUR E-SHOP

Manufacturer:
Waters

Part number:
186002780

96X

1-channel pipettes					
10 μ L	120 μ L	300 μ L	1000 μ L	5mL	10mL
✓	✓	✓	✓	✓	⚠

8-channel pipettes			
10 μ L	120 μ L	300 μ L	1200 μ L
✓	✓	✓	✓



EXTRACTION +
EXTRACTION LABWARE
Direct Compatibility
PN: 176005201/-202

Waters Sirocco™ 96-well protein precipitation plate



SEE THIS CONSUMABLE
ON OUR E-SHOP

Manufacturer:
Waters

Part number:
186003873

96X

1-channel pipettes					
10µL	120µL	300µL	1000µL	5mL	10mL
✓	✓	✓	✓	✓	500

8-channel pipettes			
10µL	120µL	300µL	1200µL
✓	✓	✓	✓



**EXTRACTION +
EXTRACTION LABWARE**
Direct Compatibility
PN: 176005201/-202

Zeba™ Spin Desalting Plate



Manufacturer:
Thermo Scientific

Part number:
A57768

96X

1-channel pipettes

10µL	120µL	300µL	1000µL	5mL	10mL
✓	✓	✓	200	100	300

8-channel pipettes

10µL	120µL	300µL	1200µL
150	✓	✓	✓



**EXTRACTION +
EXTRACTION LABWARE**
Direct Compatibility
PN: 176005201/-202

COMPATIBILITY VIA 1CC CARTRIDGE ADAPTOR

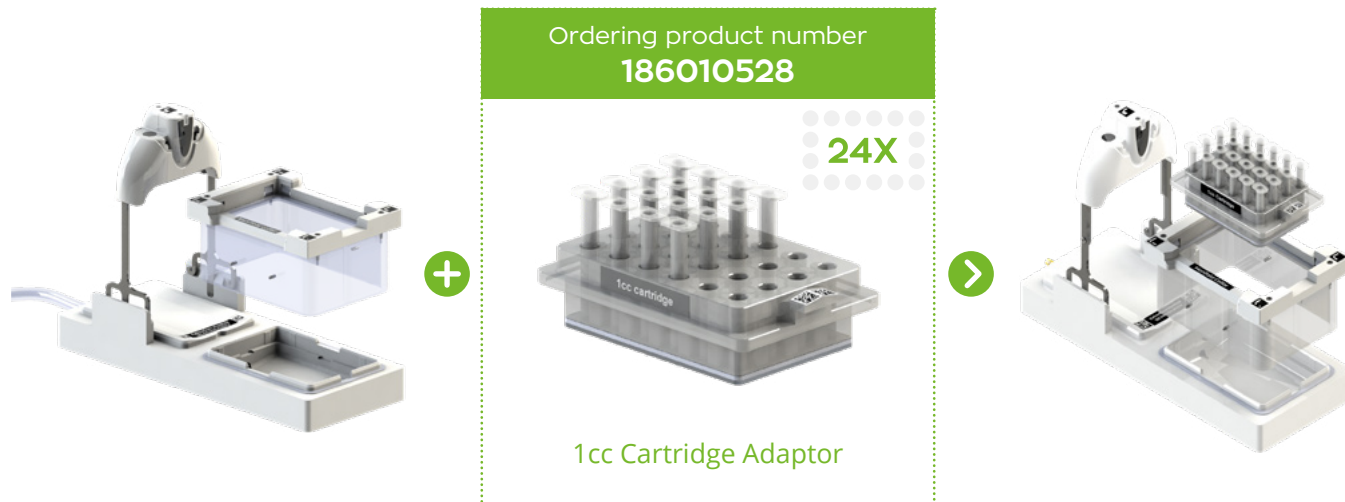

The 1cc Cartridge Adaptor is required for the following extraction labware to be compatible with Extraction+

IMPORTANT

The 1cc Cartridge Adaptor can be purchased individually or as part of the Extraction+ 1cc Cartridge Kit for seamless compatibility and full automation with your preferred collection labware.

**SEE THIS KIT
ON OUR E-SHOP**



Pack of 24x 1cc Sealing Caps
186010535

1cc Cartridge Adaptor
186010528

Ø12mm vial Collection Rack
186010531

Collection Labware Rack Domino
186010523

Extraction+ 1cc Cartridge Kit
176005204

Oasis HLB 1 cc Vac cartridge, 10 mg sorbent, 30 μ m, racked



SEE THIS CONSUMABLE
ON OUR E-SHOP

Manufacturer:
Waters Corporation

Part number:
186000383

24X

1-channel pipettes

10 μ L	120 μ L	300 μ L	1000 μ L	5mL	10mL
700	400	400			

8-channel pipettes

10 μ L	120 μ L	300 μ L	1200 μ L



+



EXTRACTION LABWARE
Compatibility via
1cc Cartridge Adaptor
PN: 176005201/-202
+ 186010528

Oasis HLB 1 cc Vac cartridge, 30 mg sorbent, 30 μ m, racked



SEE THIS CONSUMABLE
ON OUR E-SHOP

Manufacturer:
Waters Corporation

Part number:
WAT094225

24X

1-channel pipettes

10 μ L	120 μ L	300 μ L	1000 μ L	5mL	10mL
700	400	400			

8-channel pipettes

10 μ L	120 μ L	300 μ L	1200 μ L



EXTRACTION LABWARE
Compatibility via
1cc Cartridge Adaptor
PN: 176005201/-202
+ 186010528

Oasis PRiME MCX 1 cc Vac cartridge, 30 mg sorbent, 30 μ m, racked



SEE THIS CONSUMABLE
ON OUR E-SHOP

Manufacturer:
Waters Corporation

Part number:
186008917

24X

1-channel pipettes

10 μ L	120 μ L	300 μ L	1000 μ L	5mL	10mL
700	400	400			

8-channel pipettes

10 μ L	120 μ L	300 μ L	1200 μ L



EXTRACTION LABWARE
Compatibility via
1cc Cartridge Adaptor
PN: 176005201/-202
+ 186010528

Sep-Pak SEC 1cc desalting cartridge, 5k MWCO, racked



SEE THIS CONSUMABLE
ON OUR E-SHOP

Manufacturer:
Waters Corporation

Part number:
186010127

24X

1-channel pipettes

10 μ L	120 μ L	300 μ L	1000 μ L	5mL	10mL
✓	✓	✓	✓	⚠	⚠

8-channel pipettes

10 μ L	120 μ L	300 μ L	1200 μ L
✗	✗	✗	✗



EXTRACTION LABWARE
Compatibility via
1cc Cartridge Adaptor
PN: 176005201/-202
+ 186010528

COMPATIBILITY VIA 3CC CARTRIDGE ADAPTOR



The 3cc Cartridge Adaptor is required for the following extraction labware to be compatible with Extraction+

IMPORTANT

The 3cc Cartridge Adaptor can be purchased individually or as part of the Extraction+ 3cc Cartridge. Kit for seamless compatibility and full automation with your preferred collection labware.

**SEE THIS KIT
ON OUR E-SHOP**

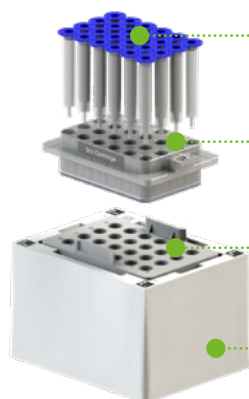

Pack of 24x 3cc Sealing Caps
186010536

3cc Cartridge Adaptor
186010529

Ø12mm vial Collection Rack
186010531

Collection Labware Rack Domino
186010523

Extraction+ 3cc Cartridge Kit
176005205

Oasis HLB 3 cc Vac cartridge, 60 mg sorbent, 30 μ m, racked



SEE THIS CONSUMABLE
ON OUR E-SHOP

Manufacturer:
Waters Corporation

Part number:
WAT094226

24X

1-channel pipettes

10 μ L	120 μ L	300 μ L	1000 μ L	5mL	10mL
✓	✓	✓	✓	2 000	2 800

8-channel pipettes

10 μ L	120 μ L	300 μ L	1200 μ L
✗	✗	✗	✗



+



EXTRACTION LABWARE
Compatibility via
3cc Cartridge Adaptor
PN: 176005201/-202
+ 186010529

Oasis HLB 3 cc flangeless Vac cartridge, 60 mg sorbent, 30 μ m, racked



SEE THIS CONSUMABLE
ON OUR E-SHOP

Manufacturer:
Waters Corporation

Part number:
186001880

24X

1-channel pipettes

10 μ L	120 μ L	300 μ L	1000 μ L	5mL	10mL
✓	✓	✓	✓	2 000	2 800

8-channel pipettes

10 μ L	120 μ L	300 μ L	1200 μ L
✗	✗	✗	✗



EXTRACTION LABWARE
Compatibility via
3cc Cartridge Adaptor
PN: 176005201/-202
+ 186010529

COMPATIBILITY VIA 6CC CARTRIDGE ADAPTOR

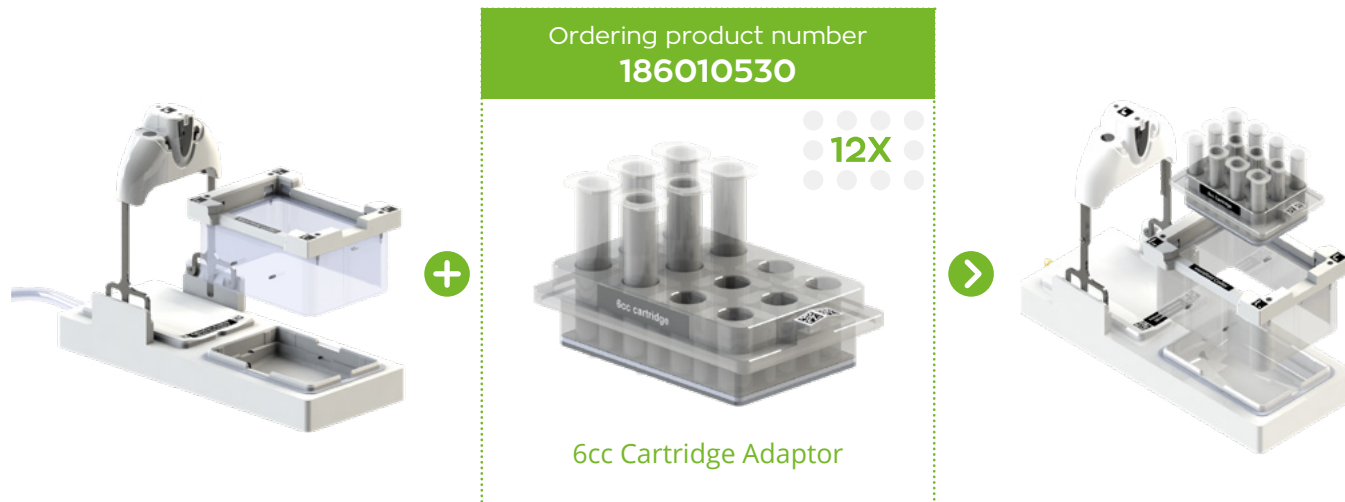

The 3cc Cartridge Adaptor is required for the following extraction labware to be compatible with Extraction+

IMPORTANT

The 6cc Cartridge Adaptor can be purchased individually or as part of the Extraction+ 6cc Cartridge Kit for seamless compatibility and full automation with your preferred collection labware.

**SEE THIS KIT
ON OUR E-SHOP**



Pack of 24x 6cc Sealing Caps
186010537

6cc Cartridge Adaptor
186010530

5mL Tube Collection Rack
186010534

Collection Labware Rack Domino
186010523

Extraction+ 6cc Cartridge Kit
176005206

Cytiva, Amersham NAP-10 DNA purification column, racked



Manufacturer:

Cytiva

Part number:

17085401



1-channel pipettes					
10 μ L	120 μ L	300 μ L	1000 μ L	5mL	10mL
✓	✓	✓	✓	✓	✓

8-channel pipettes			
10 μ L	120 μ L	300 μ L	1200 μ L
✗	✗	✗	✗



EXTRACTION LABWARE
Compatibility via
6cc Cartridge Adaptor
PN: 176005201/-202
+ 186010530

Oasis HLB 6 cc Vac cartridge, 150 mg sorbent, 30 µm, racked



SEE THIS CONSUMABLE
ON OUR E-SHOP

Manufacturer:
Waters Corporation

Part number:
186003365

12X

1-channel pipettes

10µL	120µL	300µL	1000µL	5mL	10mL
✓	✓	✓	✓	✓	✓

8-channel pipettes

10µL	120µL	300µL	1200µL
✗	✗	✗	✗



+



EXTRACTION LABWARE
Compatibility via
6cc Cartridge Adaptor
PN: 176005201/-202
+ 186010530

Oasis HLB 6 cc Vac cartridge, 200 mg sorbent, 30 μ m, racked



SEE THIS CONSUMABLE
ON OUR E-SHOP

Manufacturer:
Waters Corporation

Part number:
WAT106202

12X

1-channel pipettes

10 μ L	120 μ L	300 μ L	1000 μ L	5mL	10mL
✓	✓	✓	✓	✓	✓

8-channel pipettes

10 μ L	120 μ L	300 μ L	1200 μ L
✗	✗	✗	✗



+



EXTRACTION LABWARE
Compatibility via
6cc Cartridge Adaptor
PN: 176005201/-202
+ 186010530

EXTRACTION+

EXTRACTION LABWARE

COMPATIBILITY VIA 8-POSITION, 6CC CARTRIDGE ADAPTOR



The 8-position, 6cc Cartridge Adaptor is required for the following extraction labware to be compatible with Extraction+

IMPORTANT

The 8-position 6cc Cartridge Adaptor can be purchased individually or as part of the Extraction+ 8-position 6cc Cartridge kit for seamless compatibility and full automation with your preferred collection labware.

**E-SHOP AVAILABILITY
COMING SOON**

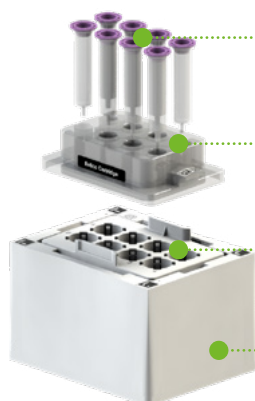

Pack of 6cc Sealing Caps
186010537

8-position 6cc Cartridge Adaptor
186011117

10mL Vial Collection Rack
186111118

Collection Labware Rack Domino
186010523

Extraction+ 6cc
8-position Cartridge Kit
176005433

Cytiva, Amersham NAP-10 DNA purification column, in 8 positions rack



Manufacturer:

Cytiva

Part number:

17085401



1-channel pipettes					
10 μ L	120 μ L	300 μ L	1000 μ L	5mL	10mL
✓	✓	✓	✓	✓	✓

8-channel pipettes			
10 μ L	120 μ L	300 μ L	1200 μ L
✗	✗	✗	✗



EXTRACTION LABWARE
Compatibility via 8-position,
6cc Cartridge Adaptor
PN: 176005201/-202
+ 186011117

Oasis HLB 6 cc Vac cartridge, 150 mg sorbent, 30 μ m, in 8 positions rack



SEE THIS CONSUMABLE
ON OUR E-SHOP

Manufacturer:
Waters Corporation

Part number:
186003365



1-channel pipettes					
10 μ L	120 μ L	300 μ L	1000 μ L	5mL	10mL
✓	✓	✓	✓	✓	✓

8-channel pipettes			
10 μ L	120 μ L	300 μ L	1200 μ L
✗	✗	✗	✗



EXTRACTION LABWARE
Compatibility via 8-position,
6cc Cartridge Adaptor
PN: 176005201/-202
+ 186011117

Oasis HLB 6 cc Vac cartridge, 200 mg sorbent, 30 μ m, in 8 positions rack



Manufacturer:
Waters Corporation

Part number:
WAT106202

SEE THIS CONSUMABLE
ON OUR E-SHOP



1-channel pipettes					
10 μ L	120 μ L	300 μ L	1000 μ L	5mL	10mL
✓	✓	✓	✓	✓	✓

8-channel pipettes			
10 μ L	120 μ L	300 μ L	1200 μ L
✗	✗	✗	✗



EXTRACTION LABWARE
Compatibility via 8-position,
6cc Cartridge Adaptor
PN: 176005201/-202
+ 186011117

DIRECT COMPATIBILITY

No adaptors are required for the following Waste and Collection labware to be compatible with the Extraction+ Device itself. Depending on the workflow requirements, they can either be directly placed inside the manifold at the start of a run or on a compatible Domino within the Andrew+ workbench.

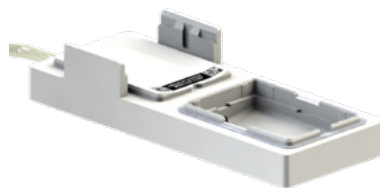

IMPORTANT

For fully automated Extraction+ workflows involving waste and collection labware movements, ensure that you are equipped with both the Andrew+ Microplate Gripper Tool and a Domino compatible with the desired waste and/or collection labware on the Andrew+ workbench.

Gripper compatibility is confirmed with the following symbol :



We'll let you know which Domino(s) you'll need to enable fully automated extraction workflows with the consumable(s) of your choice :



For seamless compatibility and full automation with your preferred waste and/or collection labware in plate formats, we highly recommend acquiring the Extraction+ Plate Kit

[SEE THIS DEVICE ON OUR E-SHOP](#)

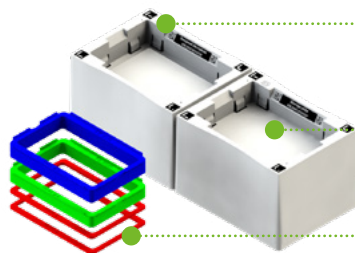

Deepwell Microplate Domino
186009597

Storage Plate Domino
186009596

Collection Plate Spacer Kit
186010527

Extraction+ Plate Kit
176005203

EXTRACTION+

WASTE & COLLECTION LABWARE

DIRECT COMPATIBILITY - 96X PLATE FORMATS

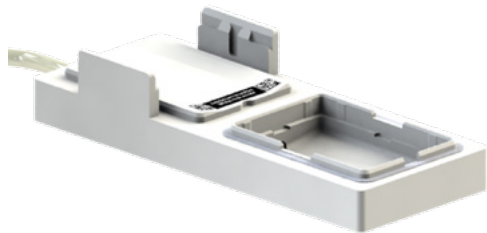

96X

Nunc™ 1.3 mL 96-DeepWell™ plate



Manufacturer:
Thermo Scientific

Part number:
260251



1-channel pipettes

10µL	120µL	300µL	1000µL	5mL	10mL
✓	✓	✓	✓	✓	✓

8-channel pipettes

10µL	120µL	300µL	1200µL
✓	✓	✓	✓



FULLY AUTOMATE WITH
Deepwell Microplate Domino
186009597



COLLECTION LABWARE

Direct Compatibility - 96X Plate Formats
PN: 176005201/-202

Riplate® Medio 1mL Deepwell Plate



Manufacturer:

Carl Roth

Part number:

TC22.1



96X

1-channel pipettes

10µL	120µL	300µL	1000µL	5mL	10mL
✓	✓	✓	✓	✓	✓

8-channel pipettes

10µL	120µL	300µL	1200µL
450	✓	✓	✓



FULLY AUTOMATE WITH
Deepwell Microplate Domino
186009597



COLLECTION LABWARE

Direct Compatibility - 96X Plate Formats
PN: 176005201/-202

Riplate® 2mL Deepwell Plate



Manufacturer:

Carl Roth

Part number:

EN07.1

96



Compatible with
Microplate
Gripper



1-channel pipettes

10µL	120µL	300µL	1000µL	5mL	10mL
✓	✓	✓	✓	800	1 200

8-channel pipettes

10µL	120µL	300µL	1200µL
600	✓	✓	✓



FULLY AUTOMATE WITH
Deepwell Microplate Domino
186009597



COLLECTION LABWARE

Direct Compatibility - 96X Plate Formats
PN: 176005201/-202

Waters 2 mL 96-square well collection plate, cut corner A1/H1



COLLECTION LABWARE
Direct Compatibility - 96X Plate Formats
PN: 176005201/-202



Manufacturer:
Waters

Part number:
WAT058958



SEE THIS CONSUMABLE
ON OUR E-SHOP



1-channel pipettes					
10 μ L	120 μ L	300 μ L	1000 μ L	5mL	10mL
✓	✓	✓	✓	300	850

8-channel pipettes			
10 μ L	120 μ L	300 μ L	1200 μ L
✓	✓	✓	✓



FULLY AUTOMATE WITH
Deepwell Microplate Domino
186009597

Waters 2 mL 96-square well collection plate, cut corner H1



Manufacturer:
Waters

Part number:
186002482



SEE THIS CONSUMABLE
ON OUR E-SHOP



1-channel pipettes					
10 μ L	120 μ L	300 μ L	1000 μ L	5mL	10mL
✓	✓	✓	✓	300	850

8-channel pipettes			
10 μ L	120 μ L	300 μ L	1200 μ L
✓	✓	✓	✓



FULLY AUTOMATE WITH
Deepwell Microplate Domino
186009597



COLLECTION LABWARE

Direct Compatibility - 96X Plate Formats
PN: 176005201/-202

Waters 350 μ L 96-round well collection plate



COLLECTION LABWARE
Direct Compatibility - 96X Plate Formats
PN: 176005201/-202



Manufacturer:
Waters Corporation

Part number:
186002643



SEE THIS CONSUMABLE
ON OUR E-SHOP



96X

1-channel pipettes

10 μ L	120 μ L	300 μ L	1000 μ L	5mL	10mL
✓	✓	✓	✓	✓	✓

8-channel pipettes

10 μ L	120 μ L	300 μ L	1200 μ L
✓	✓	✓	✓



FULLY AUTOMATE WITH
Deepwell Microplate Domino
186009597

Waters 700 μ L 96-round well collection plate



COLLECTION LABWARE
Direct Compatibility - 96X Plate Formats
PN: 176005201/-202



Manufacturer:
Waters

Part number:
186005837



SEE THIS CONSUMABLE
ON OUR E-SHOP



96X

1-channel pipettes					
10 μ L	120 μ L	300 μ L	1000 μ L	5mL	10mL
✓	✓	✓	100	100	

8-channel pipettes			
10 μ L	120 μ L	300 μ L	1200 μ L
200	✓	✓	✓



FULLY AUTOMATE WITH
Deepwell Microplate Domino
186009597

Waters 800 μ L 96-round well collection plate



COLLECTION LABWARE
Direct Compatibility - 96X Plate Formats
PN: 176005201/-202



Manufacturer:
Waters Corporation

Part number:
186002481



SEE THIS CONSUMABLE
ON OUR E-SHOP



1-channel pipettes					
10 μ L	120 μ L	300 μ L	1000 μ L	5mL	10mL
✓	✓	✓	50	200	400

8-channel pipettes			
10 μ L	120 μ L	300 μ L	1200 μ L
200	✓	✓	✓



FULLY AUTOMATE WITH
Deepwell Microplate Domino
186009597

Waters GlycoWorks™ 600 µL tubes in 96x plate



Manufacturer:
Waters

Part number:
186007988-3



SEE THIS CONSUMABLE
ON OUR E-SHOP



1-channel pipettes

10µL	120µL	300µL	1000µL	5mL	10mL
120	✓	✓	300	300	

8-channel pipettes

10µL	120µL	300µL	1200µL
120	✓	✓	300



FULLY AUTOMATE WITH
Deepwell Microplate Domino
186009597



COLLECTION LABWARE

Direct Compatibility - 96X Plate Formats
PN: 176005201/-202

Waters QuanRecovery™ 700 µL 96-well plate



COLLECTION LABWARE
Direct Compatibility - 96X Plate Formats
PN: 176005201/-202



Manufacturer:
Waters

Part number:
186009185



SEE THIS CONSUMABLE
ON OUR E-SHOP



1-channel pipettes					
10µL	120µL	300µL	1000µL	5mL	10mL
✓	✓	✓	50	200	400

8-channel pipettes			
10µL	120µL	300µL	1200µL
200	✓	✓	✓



FULLY AUTOMATE WITH
Deepwell Microplate Domino
186009597

EXTRACTION+

WASTE & COLLECTION LABWARE

DIRECT COMPATIBILITY - 24X PLATE FORMATS

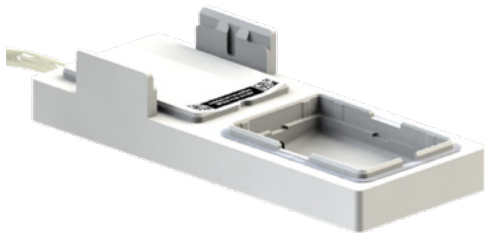

24X

AcroPrep™ 24-well collection plate



Manufacturer:
Pall Corporation

Part number:
NA



1-channel pipettes

10 μ L	120 μ L	300 μ L	1000 μ L	5mL	10mL
✓	✓	✓	✓	✓	✓

8-channel pipettes

10 μ L	120 μ L	300 μ L	1200 μ L
✗	✗	✗	✗



FULLY AUTOMATE WITH
Deepwell Microplate Domino
186009597



COLLECTION LABWARE

Direct Compatibility - 24X Plate Formats
PN: 176005201/-202

Axygen® 10 mL 24-square deep well V-bottom plate



Manufacturer:

Corning Inc.

Part number:

P-DW-10ML-24-C-S



1-channel pipettes					
10µL	120µL	300µL	1000µL	5mL	10mL
✓	✓	✓	✓	✓	✓

8-channel pipettes			
10µL	120µL	300µL	1200µL
✗	✗	✗	✗



FULLY AUTOMATE WITH
Deepwell Microplate Domino
186009597



COLLECTION LABWARE

Direct Compatibility - 24X Plate Formats
PN: 176005201/-202

Sartorius, 24-deep well V-bottom plate



Manufacturer:
Sartorius

Part number:
A-0038



24X

1-channel pipettes

10 μ L	120 μ L	300 μ L	1000 μ L	5mL	10mL
✓	✓	✓	✓	✓	✓

8-channel pipettes

10 μ L	120 μ L	300 μ L	1200 μ L
✗	✗	✗	✗



FULLY AUTOMATE WITH
Deepwell Microplate Domino
186009597



Waters 10 mL 24-square well collection plate



Manufacturer:
Waters Corporation

Part number:
186005586



SEE THIS CONSUMABLE
ON OUR E-SHOP



24X

1-channel pipettes

10 μ L	120 μ L	300 μ L	1000 μ L	5mL	10mL
✓	✓	✓	✓	✓	✓

8-channel pipettes

10 μ L	120 μ L	300 μ L	1200 μ L
✓	✓	✓	✓



FULLY AUTOMATE WITH
Deepwell Microplate Domino
186009597



COLLECTION LABWARE

Direct Compatibility - 24X Plate Formats
PN: 176005201/-202

EXTRACTION+

WASTE & COLLECTION LABWARE

DIRECT COMPATIBILITY - 12X PLATE FORMATS

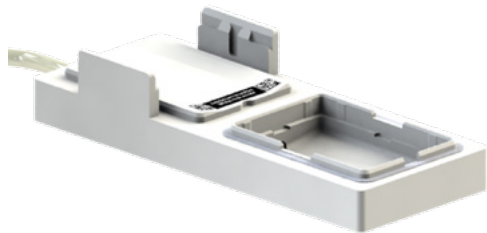



COLLECTION LABWARE

Direct Compatibility - 12X Plate Formats
PN: 176005201/-202

COMING SOON

EXTRACTION+

WASTE & COLLECTION LABWARE

DIRECT COMPATIBILITY - 8X PLATE FORMATS

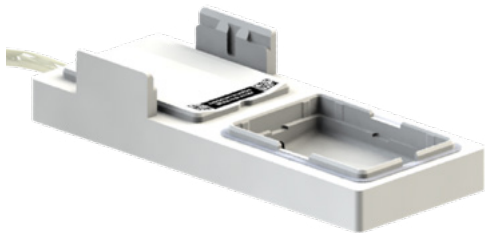



COLLECTION LABWARE

Direct Compatibility - 8X Plate Formats
PN: 176005201/-202

COMING SOON

EXTRACTION+

WASTE & COLLECTION LABWARE

DIRECT COMPATIBILITY - 1X PLATE FORMATS

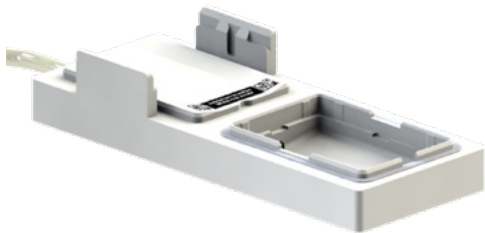

1X

ArcticWhite, 290 mL single cavity reservoir



Manufacturer:
ArcticWhite LLC

Part number:
AWLS-S30017



1X

1-channel pipettes					
10 μ L	120 μ L	300 μ L	1000 μ L	5mL	10mL
✓	✓	✓	✓	✓	✓

8-channel pipettes			
10 μ L	120 μ L	300 μ L	1200 μ L
✓	✓	✓	✓



FULLY AUTOMATE WITH
Deepwell Microplate Domino
186009597



COLLECTION LABWARE
Direct Compatibility - 1X Plate Formats
PN: 176005201/-202

Axygen® 96 V-bottom single well reservoir



Manufacturer:
Corning Inc.

Part number:
RES-SW96-HP-SI



1X

1-channel pipettes

10µL	120µL	300µL	1000µL	5mL	10mL
✓	✓	✓	✓	✓	✓

8-channel pipettes

10µL	120µL	300µL	1200µL
✓	✓	✓	✓



FULLY AUTOMATE WITH
Deepwell Microplate Domino
186009597

EXTRACTION+

WASTE & COLLECTION LABWARE

COMPATIBILITY VIA 5ML TUBE COLLECTION RACK - 12X

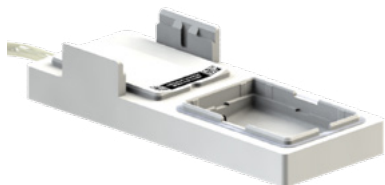

Ordering product number

186010534

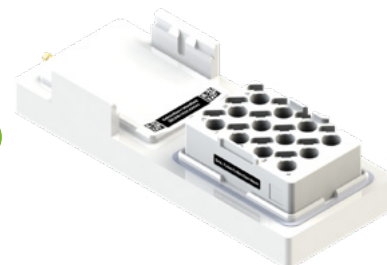

5mL Tube Collection Rack
OneLab reference: [519.2651]



IMPORTANT

For fully automated Extraction+ workflows involving the movements of collection labware via the 5mL Tube Collection Rack, ensure that you are equipped with both the Andrew+ Microplate Gripper Tool and the Collection Labware Rack Domino.

The 5mL Tube Collection Rack is a 12x (3x4) format Collection Rack. As of such, it is only compatible with 12x Extraction labware. Look out for the 12x compatibility symbol when selecting your Extraction Labware.

VWR® 5 mL snap-cap centrifuge tube



Manufacturer:
VWR International

Part number:
10002-728

1-channel pipettes					
10µL	120µL	300µL	1000µL	5mL	10mL
✓	✓	✓	✓	✓	✓

8-channel pipettes			
10µL	120µL	300µL	1200µL
✗	✗	✗	✗



FULLY AUTOMATE WITH
Collection Labware
Rack Domino
186010523



+



COLLECTION LABWARE:
Compatibility via
5mL Tube Collection Rack
PN: 176005201/-202
+ 186010534

EXTRACTION+

WASTE & COLLECTION LABWARE

COMPATIBILITY VIA Ø12MM VIAL COLLECTION RACK - 24X

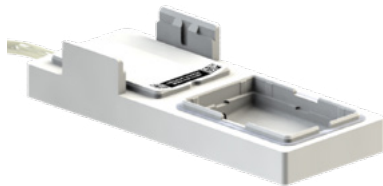

Ordering product number
186010531

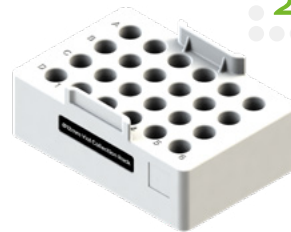

24X

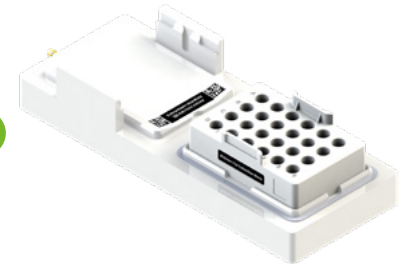

Ø12mm Vial Collection Rack

OneLab reference: [519.2601]



IMPORTANT

For fully automated Extraction+ workflows involving the movements of collection labware via the ø12mm Vial Collection Rack, ensure that you are equipped with both the Andrew+ Microplate Gripper Tool and the Collection Labware Rack Domino.

The ø12mm Vial Collection Rack is a 24x (4x6) format Collection Rack. As of such, it is only compatible with 24x Extraction labware. Look out for the 24x compatibility symbol when selecting your Extraction Labware.

Waters 2 mL 12x32 mm LC/GC screw-top vial, racked



Manufacturer:
Waters Corporation

Part number:
186000272C

SEE THIS CONSUMABLE
ON OUR E-SHOP

1-channel pipettes

10µL	120µL	300µL	1000µL	5mL	10mL
✓	✓	✓	1 000	🧪	🧪

8-channel pipettes

10µL	120µL	300µL	1200µL
✗	✗	✗	✗



FULLY AUTOMATE WITH
Collection Labware
Rack Domino
186010523

COLLECTION LABWARE
Compatibility via ø12mm
Vial Collection Rack – 24x
PN: 176005201/-202
+ PN: 186010531



Waters 300 µL 12x32mm screw neck vial, racked



Manufacturer:
Waters Corporation

Part number:
186002639

SEE THIS CONSUMABLE
ON OUR E-SHOP

1-channel pipettes					
10µL	120µL	300µL	1000µL	5mL	10mL
✓	✓	✓	150	🧪	🧪

8-channel pipettes			
10µL	120µL	300µL	1200µL
✗	✗	✗	✗



FULLY AUTOMATE WITH
Collection Labware
Rack Domino
186010523

COLLECTION LABWARE
Compatibility via ø12mm
Vial Collection Rack – 24x
PN: 176005201/-202
+ PN: 186010531



Waters 700 μ L 12x32mm screw neck vial, racked



Manufacturer:
Waters Corporation

Part number:
186005221

SEE THIS CONSUMABLE
ON OUR E-SHOP

1-channel pipettes					
10 μ L	120 μ L	300 μ L	1000 μ L	5mL	10mL
✓	✓	✓	500	🧪	🧪

8-channel pipettes			
10 μ L	120 μ L	300 μ L	1200 μ L
✗	✗	✗	✗



FULLY AUTOMATE WITH
Collection Labware
Rack Domino
186010523

COLLECTION LABWARE
Compatibility via \varnothing 12mm
Vial Collection Rack – 24x
PN: 176005201/-202
+ PN: 186010531



Waters QuanRecovery™ 300 µL 12x32mm screw neck vial, racked



Manufacturer:
Waters Corporation

Part number:
186009186

SEE THIS CONSUMABLE
ON OUR E-SHOP

1-channel pipettes					
10µL	120µL	300µL	1000µL	5mL	10mL
✓	✓	✓	150	🧪	🧪

8-channel pipettes			
10µL	120µL	300µL	1200µL
✗	✗	✗	✗



FULLY AUTOMATE WITH
Collection Labware
Rack Domino
186010523



COLLECTION LABWARE
Compatibility via ø12mm
Vial Collection Rack – 24x
PN: 176005201/-202
+ PN: 186010531

EXTRACTION+

WASTE & COLLECTION LABWARE

COMPATIBILITY VIA 4ML VIAL COLLECTION RACK - 24X

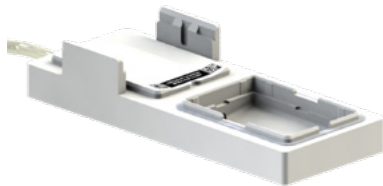

Ordering product number

18601193



24X



4mL Vial Collection Rack
OneLab reference: [519.2800]



IMPORTANT

For fully automated Extraction+ workflows involving the movements of collection labware via the 4mL Vial Collection Rack, ensure that you are equipped with both the Andrew+ Microplate Gripper Tool and the Collection Labware Rack Domino.

The 4mL Tube Collection Rack is a 24x (4x6) format Collection Rack. As of such, it is only compatible with 24x Extraction labware. Look out for the 24x compatibility symbol when selecting your Extraction Labware.

Clear Glass 4 mL Screw Neck Vial, racked



Manufacturer:
Waters Corporation

Part number:
186000840

SEE THIS CONSUMABLE
ON OUR E-SHOP

1-channel pipettes					
10µL	120µL	300µL	1000µL	5mL	10mL
✓	✓	✓	✓	1 500	2 700

8-channel pipettes			
10µL	120µL	300µL	1200µL
✗	✗	✗	✗



FULLY AUTOMATE WITH
Collection Labware
Rack Domino
186010523



COLLECTION LABWARE
Compatibility via 4mL
Vial Collection Rack
PN: 176005201/-202
+ PN: 186011193

EXTRACTION+

WASTE & COLLECTION LABWARE

COMPATIBILITY VIA 10ML VIAL COLLECTION RACK - 8X

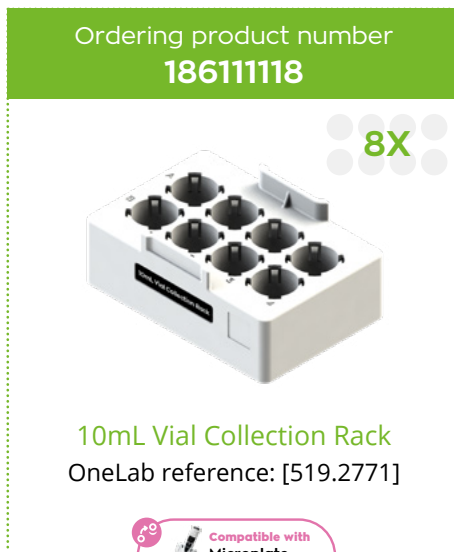
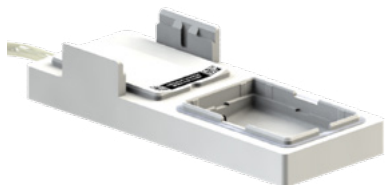

10mL Vial Collection Rack
OneLab reference: [519.2771]

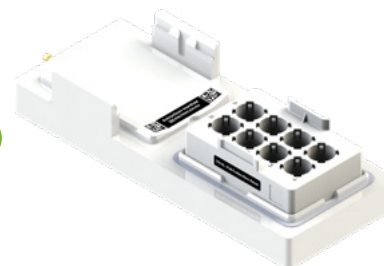

IMPORTANT

For fully automated Extraction+ workflows involving the movements of collection labware via the 10mL Vial Collection Rack, ensure that you are equipped with both the Andrew+ Microplate Gripper Tool and the Collection Labware Rack Domino.

The 10mL Vial Collection Rack is a 8x (2x4) format Collection Rack. As of such, it is only compatible with 8x Extraction labware. Look out for the 8x compatibility symbol when selecting your Extraction Labware.

WHEATON® 10 mL clear glass serum vial, racked



Manufacturer:
DWK Life Sciences

Part number:
223686

1-channel pipettes					
10µL	120µL	300µL	1000µL	5mL	10mL
✓	✓	✓	✓	✓	✓

8-channel pipettes			
10µL	120µL	300µL	1200µL
✗	✗	✗	✗



FULLY AUTOMATE WITH
Collection Labware
Rack Domino
186010523

COLLECTION LABWARE
Compatibility via 10mL
Vial Collection Rack
PN: 176005201/-202
+ PN: 186111118

